



REKVISITA OG FELGTTILBEHØR

BOLTER - MUTTERE - SPACERE - LAPPESAKER - VERKTØY - VEKTER - VENTILER

**PRODUKT
KATALOG
2022**

www.norgesdekk.no





Norgesdekk er importør og grossist av dekk og felger. Med kjente merkevarer innenfor de forskjellige prissegmenter, inntar vi rollen som en av landets ledende aktører innen både dekk og felg.

Vi ønsker å se at våre medarbeidere har optimal produktkunnskap, samtidig som vi er svært opptatt av å kunne levere raskt og effektivt til våre kunder. Dette betyr at våre samarbeidspartnere slipper å ligge med store lager, og dermed kan få rask leveranse fra et av våre lager i Norge.

NORGESDEKK TØNSBERG

Avdelingen er nå flyttet til nye, større og moderne lokaler, strategisk plassert på logistikk området på Borgeskogen, tett ved E18, 14 km syd for Tønsberg og 18 km nord for Sandefjord. Anlegget er på 17000m2 tomt og tett på 7000m2 lager og kontor. Avdelingen er fullsortiment som skal ha alle varegrupper på lager. Avdelingen har en lagerkapasitet 4 ganger så stor som tidligere.



NORGESDEKK AS, avd Bergen
Nordre Toppe 6
5878 Bergen
Tlf. 4000 1800
bergen@norgesdekk.no

NORGESDEKK AS, avd Kristiansand
Stemmane 6
4636 Kristiansand
Tlf. 4000 1800
kristiansand@norgesdekk.no

NORGESDEKK AS, avd Oslo
Landskaugveien 54
1914 Ytre Enebakk
Tlf. 4000 1800
oslo@norgesdekk.no

NORGESDEKK AS, avd Narvik
Ornesveien 5
8517 Narvik
Tlf. 4000 1800
narvik@norgesdekk.no

NORGESDEKK AS, avd Jæren
Jærvn. 338
4322 Sandnes
Tlf. 4000 1800
post@norgesdekk.no

NORGESDEKK AS, avd Tønsberg
Borgeskogsvingen 15
3160 Stokke
Tlf. 4000 1800
tonsborg@norgesdekk.no

NORGESDEKK AS, avd Trondheim
Øybergveien 133
7224 Melhus
Tlf. 4000 1800
trondheim@norgesdekk.no

SALGS, GARANTI- OG RETURBETINGELSER

Vi forbeholder oss retten til å endre priser uten foregående varsel. Alle ordrer vil bli fakturert med gjeldende pris på leveringsdato. Vi tar forbehold om feiltrykk i denne produktliste. Ved for sen betaling beregnes morarenter etter den til enhver tid gjeldende sats. Norgesdekk (ND) har eiendomsrett til alle varer levert av ND frem til fullstendig betaling (inkl. evt. renter) er betalt.

Ordrer under 3500,- netto, belastes med gebyr, kr. 140,-.

Hvis kunde mottar varer med skader påvirket av ytre omsendigheter/transport, feil antall eller mangler, plikter han å anføre dette på fraktbrev og få transportørens signatur, for så å straks og senest innen 7 dager melde dette til ND. Uten dette kan ikke ND rette opp i slike tilfeller. Returbetingelser

Det er ikke returrett på noen varer med mindre dette er avtalt med ND. Retur av standard varer belastes med et gebyr på 10% returgebyr i tillegg til faktisk frakt. Spesialbestilte (ikke lagerstandard) varer tas ikke i retur. Varer som har vært montert, brukt, ikke er i original emballasje eller er utgått tas ikke i retur. Det samme gjelder varer på spesielle kampanjer eller sell off. Varer som er kjøpt for mer enn 12 mnd. siden, tas ikke i retur. Alle varer som blir returnert i henhold til avtale skal ha kopi av faktura fra ND med, sammen med referanse på hvilken person i ND som har godkjent retur. ND betaler ikke returfrakt.

Garantibestemmelser

ND gir 2 års reklamasjonsrett for fabrikkfeil på alle felger og dekk, regnet fra salgsdato. Eventuelle reklamasjoner meldes til din selger i ND, på ND sitt reklamasjonsskjema. Dette skal gjøres straks problem er oppdaget. Uten at reklamasjonsskjema er korrekt utfyllt

og innsendt, sammen med kjøpskvitte/faktura vil ikke reklamasjonsbehandling skje. Bilder av dekk eller felg skal vise skade/problem. Og på dekk, produksjons uke og år, samt produksjonsnummer. På felg skal også bakside av felg gjøres ren slik at info som står på felgens innside kan leses på bilde. Fraktkostnader ved en evt. innsendelse av produkt som ikke blir godkjent som garantisak, må dekkes fullt ut av kunde. Ingen produkter skal sendes inn til ND uten avtale om det, kun bilder og reklamasjonsskjema i første omgang.

Ventiler

Personbil - Varebil - MC - Landbruk - Last..... Side 4-6

Avballanseringsveker

Personbil - Varebil - MC/Scooter..... Side 7

Verktøy etc

Verktøy for dekkreparasjon..... Side 8

Ventilverktøy - pasta etc..... Side 9

Dekkstativ - Felgkrok..... Side 10

Dekkposer - Mutterposer..... Side 11

TECH

Slangelapper - Lim - Cordforsterkning..... Side 12-13

TPMS

VDO Ateq VT56..... Side 14

VDO sensorer..... Side 15

HUF sensorer..... Side 16

EZ Sensorer..... Side 16

Italsensor..... Side 17

Muttere

STD Muttere 60°..... Side 18-20

Muttere Kulekon - US muttere..... Side 21

Torx Muttere - Verktøy..... Side 22-23

Slingremutter..... Side 31

Bolter

STD Bolter 60°..... Side 24-27

Bolter Kulekon..... Side 28-30

Slingrebolter..... Side 31

Torx Bolter..... Side 32-33

Sentreringsringer

Ringer Plast & Aluminium..... Side 34-35

Spacere

Bimecc Spacere..... Side 36

Athena Spacere..... Side 37

OE Tilbehør

Bolter og muttere for originale felger..... Side 38-55

*Norgesdekk kjøper også varer fra alternative leverandører.
Dette kan medføre at både varenummer og priser
er avvikende på samme type varer.*

VENTILER

SLANGELØSE SNAP-IN VENTILER



Varenr	ETRTO nr	Felghull	Effektiv Lengde
NDTR412	V2.03.6	11.5 MM	22 MM
NDTR413	VB.03B1	11.5 MM	32 MM
NDTR414	V2.03.2	11.5 MM	38 MM
NDTR415	V2.03.3	15.8 MM	32 MM
NDTRC1R			Ventilnål pk à 100 stk
NDGR15			Plastforing TR13 - TR15 (pris pr stk)

65 PSI ER MAKSTRYKK FOR STANDARD GUMMIVENTILER.



OM SNAP-IN VENTILER:

- Forsterket ventilfjær.
- Alle ventilstammer er testet hos fabrikk.
- Tetning til høye temperaturer for luft og nitrogen.
- Kjernekommer tilpasset maks luftstrømming.
- Premium EPDM gummi for å motstå tørråte.

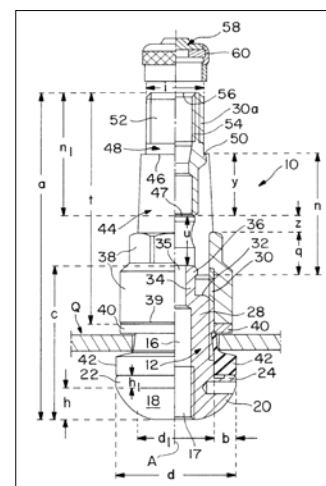

Varenr	ETRTO nr	Felghull	Effektiv Lengde
NDTR412C	V2.03.6	11.5 MM	22 MM
NDTR413C	VB.03B1	11.5 MM	32 MM
NDTR414C	V2.03.2	11.5 MM	38 MM

65 PSI ER MAKSTRYKK FOR STANDARD CHROME GUMMIVENTILER.



Varenr	ETRTO nr	Felghull	Effektiv Lengde
NDTR600HP	V3.23.1	11,5 MM	32 MM

NDTR600 HP ER "HIGH PRESSURE" VENTILER MED FORSTERKET STAMME, BEREGNET TIL BOBILER OG VAREBILER.

VENTILER

SLANGELØSE BOLT-IN OG MC VENTILER



Varenr	Felghull	Lengde	Info
NDMS525-A	11,5 MM	38 MM	ALUMINIUM
NDMS532	11,5 MM	38 MM	CHROME STD
NDVS6	6 MM	40 MM	CHROME



NDMS525-A NDMS532 NDVS6



Varenr	Felghull	Lengde	Info
NDTR430A	11,5 MM	33 MM	CHROME
NDVAMD-161	11,5 MM	34 MM	CHROME
NDPVR-70	11,5 MM	30 MM	90° GUMMIFOT
NDTV25AL	11,5 MM	15X25 MM	90° ALUMINIUM
NDTV25AL-B	11,5 MM	15X25 MM	90° ALUMINIUM SORT



NDVAMD-161 NDTR430A NDPVR-70



NDTV25AL NDTV25AL-B



Varenr	Type	Lengde	Info
NDSME153TP	Ventilforlenger	170 MM	Hardplast
NDSMHR140	Ventilforlenger	140 MM	Gummi



NDSME153TP NDSMHR140

*Norgesdekk kjøper også varer fra alternative leverandører.
Dette kan medføre at både varenummer og priser
er avvikende på samme type varer.*

VENTILER

LANDBRUK - LAST - ANLEGG

PART
#



Varenr	ETRTO nr	Felghull	Effektiv Lengde
NDTR618A	V5.01.1	16 MM	32 MM
NDTR618		16 MM	32 MM



NDTR618A



NDTR618

OM TRAKTOR VENTILER:

- Forsterket ventilfjær.
- Alle ventiler er testet hos fabrikk.
- Tetning til høye temperaturer for luft.
- Premium EPDM gummi for å motstå tørråte på NDTR618.

PART
#



Varenr	ETRTO nr	Felghull	Effektiv Lengde	Vinkel
NDV3201	V3.20.1	9,7 MM	41 MM	
NDV3204	V3.20.4	9,7 MM	90 MM	27°
NDV3206	V3.20.6	9,7 MM	115 MM	27°
NDV3121	V3.12.1	16 MM	40 MM	90°
NDTR555D		9,7MM	89 MM	60°
NDTR553C		9,7 MM	60 MM	45°



NDV3.20.1



NDV3.20.4



NDV3.20.6



NDV3.12.1



NDTR555D



NDTR553C

PART
#



Varenr			Effektiv Lengde	Vinkel
NDTRJ650-3	Komplett	m/fot	27+80 MM	100°
NDTRJ651-3	Komplett	m/fot	32+119	90°
NDSMAD1	Ventilovergang			
NDSMVC2	Ventilhette EM	m/splitt		
NDTRC2	Ventilnål EM			



NDTRJ650-3



NDTRJ651-3



NDSMAD1



NDSMVC2



NDTRC2



AVBALLANSERINGSVEKTER FOR ALUMINIUMSFELGER OG STÅLFELGER

PART #		PART #		
Vekt (gr)	Varenr Alufelger	Pris	Varenr Stålfelger	Pris
5 gr	NDZA005	290,-	NDZS005	250,-
10 gr	NDZA010	290,-	NDZS010	270,-
15 gr	NDZA015	317,-	NDZS015	296,-
20 gr	NDZA020	356,-	NDZS020	323,-
25 gr	NDZA025	390,-	NDZS025	369,-
30 gr	NDZA030	428,-	NDZS030	409,-
35 gr	NDZA035	231,-	NDZS035	218,-
40 gr	NDZA040	258,-	NDZS040	244,-

Norgesdekk kjøper også vekter fra alternative leverandører. Dette kan medføre at både varenummer og priser er avvikende på samme type varer.



NDZA...



NDZS...



TIPS!
Søk 15gr om du ønsker 15 grams vekter under kategori rekvisita i vår nettbutikk

PART

Varenr				
NDKL5-5-6KG	Sølv	5/5gr	6 KG	
ITM3090882RN	Sølv	5/5gr	6 KG	Europeisk Kvalitet
NDKLBL5-5-6KG	Sort	5/5gr	6 KG	
ITM3090882RBN	Sort	5/5gr	6 KG	Europeisk Kvalitet



Stativ til klebevekt ruller kommer!
Sjekk rekvisita i vår nettbutikk.
Søk: stativ

PART

Varenr			
NDMB10	Forpakning 50 stk	10 gr	Spilevekt MC
NDMB15	Forpakning 50 stk	15 gr	Spilevekt MC
NDMB20	Forpakning 50 stk	20 gr	Spilevekt MC
NDMB25	Forpakning 50 stk	25 gr	Spilevekt MC
NDMB30	Forpakning 50 stk	30 gr	Spilevekt MC
NDFMB5-12	Forpakning 50 stk	12x5 gr	Klebevekt MC



REKVISITA

DEKKREPERASJON - VERKTØY

PART
#

Varenr		Forpakning
NDTRT75-5	Pluggehentak for hurtigplugg	
NDTRT75-1	Handfres for hurtigplugg	
NDTSR3R	Fiberplugg 3 mm	100 STK
NDTSR4R	Fiberplugg 3,5 mm	50 STK
NDVT08-5	Lapperulle for slangelapper og innlegg	
NDCC3	Carbide Cutter 3 mm	
NDCC45	Carbide Cutter 4,5 mm	
NDCC6	Carbide Cutter 6 mm	
NDCC8	Carbide Cutter 8 mm	
NDCC10	Carbide Cutter 10 mm	
NDTRTK-3	Lappe/ Pluggesett for nødreparasjon	



NDTRT75-4



NDTRT75-1



NDTSR4R



NDVT08-5



CARBIDE CUTTER



NDTRTK-4

PART
#

NDVT3-1	Ventildrager	Ventilmonteringsverktøy
NDVT02D	Ventiltrekker (snitt)	For STD og EM ventil
NDTPK101	Pastakost	
NDVT18	Ventildrager	Snap in
ND50038	Monteringspasta	5kg
NDVT13-G	Vektetang	
NDVT17H	Plastskrape	For klebevekter
NDTM01-A	Mønsterybde måler	
NDSMPT01	Boltsirkelmåler	



NDVT03-1



NDVT02D



NDVT18



NDVT13-G



NDVT17H

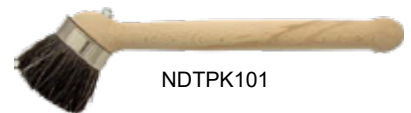

NDTPK101



ND50038



NDSMPT01



NDTM01-A

TIPS!

BRUK VARENUMMER ELLER DELER AV BESKRIVELSE FOR Å
SØKE I VÅR NETTBUTIKK,

REKVISITA

DEKKSTATIV - FELGKROK

PART
#

Varenr			Forpakning
NTODLUL	Dekkstativ Liten	15cm~28cm	STK
NTODSUL	Dekkstativ Stor	20cm~42cm	STK
NTODLNDL	Dekkstativ Liten Norgesdekk Logo	15cm~28cm	STK
NTODSNDL	Dekkstativ Stor Norgesdekk Logo	20cm~42cm	STK
MAK9900000807	MAK krok for å montere felg på vegg		STK



MAK9900000807

POSER ETC MUTTERBOSER - DEKKPOSER

PART
#

Varenr

NTODPFAND	Mutter/boltpose		100 STK
NTODPFAND	Dekkpose m/trykk	Norgesdekk/Falken	250 STK
ITM3080062F	Dekkpose u/trykk	Heavy Duty 40my	100 STK



Norgesdekk AS får produsert mutter/ boltposer med logoer etter eget ønske.

Posene blir produsert i slitesterkt tøy materiale.



REKVISITA

TECH SLANGELAPPER LIM - ETC

PART
#

Varenr	Type	Størrelse	Form	Forpakning
TEC11	Slangelapp	Ø45mm	Rund	40 stk
TEC12	Slangelapp	Ø60mm	Rund	30 stk
TEC13	Slangelapp	Ø80mm	Rund	20 stk
TEC14	Slangelapp	Ø100mm	Rund	20 stk
TEC17	Slangelapp	65x40mm	Oval	30 stk
TEC18	Slangelapp	100x50mm	Oval	20 stk
TEC19	Slangelapp	150x70mm	Oval	20 stk
TEC20	Slangelapp	160x100mm	Oval	10 stk



PART
#

Varenr	Produkt	
TEC704E	Tech Rub-O-Matic	945ml
TEC735	Tech Bead Sealer	0,9L
TEC760	Tech Vulk Cement. Brukes til alle slange-lapper og innlegg	800Z



TECH - Grunnlagt i 1939 av Charles Cornell. Pioner i kald vulkaniseringsprosess. Reparerte dekk uten varme, og revolusjonerte dekkbransjen. I dag produserer TECH et komplett utvalg av reparasjonsmaterialer, inkludert radial og bias innlegg, samt vulkaniseringsmidler.

Vi har her listet et lite utvalg fra deres sortiment.

PART
#

Varenr	Betegnelse	Pr.	Størrelse	Forpakning	
TEC165	CT-10		Radial innlegg	45x75mm	20 stk
TEC167	CT-12		Radial innlegg	60x110mm	10 stk
TEC169	CT-14		Radial innlegg	75x145mm	10 stk
TEC170	CT-20		Radial innlegg	75x125mm	10 stk
TEC177	CT-33		Radial innlegg	100x125mm	10 stk
TEC178	CT-35		Radial innlegg	125x150mm	10 stk
TECT40	CT-40		Radial innlegg	100x125mm	10 stk
TEC196	CT-80		Radial innlegg	150X195mm	5 stk
TEC197	CT-82		Radial innlegg	190x250mm	5 stk
TEC603	BP-3	Pr. 2	Diagonal innlegg	100x100mm	10 stk
TEC604	BP-4	Pr. 4	Diagonal innlegg	130x130mm	10 stk
TEC605	BP-5	Pr. 4	Diagonal innlegg	165x165mm	10 stk
TEC606	BP-6	Pr. 6	Diagonal innlegg	240x240mm	5 stk
TEC607	BP-7	Pr. 6	Diagonal innlegg	290x290mm	5 stk
TEC608	BP-8	Pr. 6	Diagonal innlegg	340x340mm	5 stk
TEC609	BP-9	Pr. 8	Diagonal innlegg	380x380mm	3 stk
TEC610	BP-10	Pr. 8	Diagonal innlegg	430x430mm	3 stk



PART
#

Varenr	Produkt	Størrelse	Forpakning
TEC249	Tech Uni-Seal	3 MM	25 STK
TEC249/4,5	Tech Uni-Seal	4,5 MM	24 STK
TEC250UL-E	Tech Uni-Seal	6 MM	24 STK
TEC251UL-E	Tech Uni-Seal	8 MM	24 STK



TPMS

VDO PRO - ATEQ VT56

Varenr

TPMSC427001-	Ateq ND41, sett med lader, USB og OBDII kabel	Ateq ND41
TPMSA2C59506457	VDO Pro - Koffert med komplett diagnose verktøy, inkludert kabler.	Ateq VT56
TPMSSTA002	Dokking stasjon uten skriver til VDO Pro - Ateq VT56	
TPMSSTA003	Dokking stasjon med skriver til VDO Pro - Ateq VT56	
TPMSSTA006	Mønsterdybdemåler til VDO Pro - Ateq VT56	
TMPSSUA001SERV	Oppdateringskode for Ateq VT56 med Alcar logo (12 mnd)	
TPMSA2C59506953	Oppdateringskode for Ateq VT56 med VDO logo (12 mnd)	
TPMS73906230	Oppdateringskode for Ateq VT56 med HUF logo (12 mnd)	

ATEQ VT56 og ND41 kan programmere sensorer til de aller fleste biler

VT56 og ND41 Settett inneholder en universal OBD-kontakt som kobles til bilens ECU via CANbus og K-line.

VT56 og ND41 er begge fulle oppdaterbare, universale TPMS verktøy. Designet for å aktivere alle TPMS sensorer og å lagre sensordata. Ved hjelp av OBDII kontakten overføres data til kjøretøyet for å tilbake stille den elektroniske styringsenheten når en sensor er erstattet eller hjul posisjoner endres. Sensorer fra de største produsentene i verden kan programmeres med VT56.

VT56 OBII settet inneholder:

- VT56 diagnostisk verktøy
- OBDII grensesnittkontakt
- OBDII til VT56 ethernet-kabel
- USB PC-kabel
- strøm adapter
- Oppdatert programvare
- Hurtigstart bruksanvisningen
- ATEQ koffert i hardplast
- Valgfri trådløs utskrift til dokkingstasjonen integrert



ATEQ

VT56 funksjoner:

- Høyoppløselig 4,3" fargeskjerm
- OBDII plassering
- Sensorer på én skjerm
- integert hjelp
- Ikon for oppæring
- Varenummer oppslag
- OBDII for ECU reset
- Datert historiefil
- Programmer til alle populære programmerbare sensorer
- Nøkkel batteri tester
- RF signal tester
- Hjelp
- WIFI-tilkobling til PC
- WIFI oppdateringer
- Strekkodeleser for vehicle identifikasjon
- Dokkingstasjon med termisk skriver
- Oppdatering via USB, WiFi og SD-kort
- DTC lese og tilbakestilling
- US / europeiske / asiatiske biler
- Relearn prosedyrer
- IP54



VDO Service Kit for TG1C

Servicekit:	
A2C59506227	1 kit
A2C59506228	
A2C59507087	
A2C59507828	
A2C59507829	
A2C59507830	
A2C59507831	
S180084500A	
S180084510A	
S180084520A	



Illustrasjonsfoto servicekit.
TG1C leveres med flere ulike kit, da med ulike lengder/farger.

Ventilstamme:	
A2C59517072	1 stk
A2C59517073	
2910000418100	



Moment mutter 8.0 Nm
Moment ventilnål 0.4 Nm



VDO Service Kit for TG1C EVO

Servicekit:	
2910000301700	1 kit
2910000418500	



Illustrasjonsfoto servicekit.
TG1C Evo leveres med ulike farger.

Ventilstamme:	
A2C59517073	1 stk
2910000418100	



Moment mutter 8.0 Nm
Moment ventilnål 0.4 Nm



VDO Tilbehør til TG1D



Moment ventilnål 0.4 Nm

Ventilstamme:	
2910000063400	1 stk



REDI-Sensor™



Redi Holder	
A2C91105300Z	1 stk



Huf IntelliSens Service Kit Clamp-In

Servicekit inkl ventilstamme:

RDV021 (sølv) RDV026 (sort) RDV027 (titan)	1 kit
--	-------



Illustrasjonsfoto servicekit.
 Leveres i ulike farger
 SØLV - SORT - TITAN



Moment mutter 4.0 Nm
 Moment ventilnål 0.4 Nm

Huf IntelliSens Service Kit Snap-In

Servicekit:

RDV041	1 stk
--------	-------



Standard Snap-In kit til alle
 HUF IntelliSens Snap-In sensorer



Moment ventilnål 0.4 Nm

EZ-sensor Service Kit 2200
Innovation by Schrader

Servicekit inkl ventilstamme:

5610	1 kit
------	-------



Illustrasjonsfoto servicekit.
 Leveres i ulike farger
 SØLV - SORT - TITAN



Moment mutter 8.0 Nm
 Moment ventilnål 0.4 Nm



Service Kit Snap-In

Servicekit:	
IT-100-V1	1 stk



Standard Snap-In kit til alle italsensor Snap-In (IT-100)



Moment ventilnål 0.4 Nm



Service Kit Clamp-In

Servicekit:	
IT-200-V1	1 kit



Standard Clamp-In kit til alle italsensor Clamp-In Sølv (IT-200)



Moment mutter 8.0 Nm
Moment ventilnål 0.4 Nm



Service Kit Clamp-In

Servicekit:	
IT-200-V1B	1 kit



Standard Clamp-In kit til alle italsensor Clamp-In Black(IT-200)



"Illustrasjonsbilde av sensor"
Moment mutter 8.0 Nm
Moment ventilnål 0.4 Nm



BOLTER OG MUTTERE

MUTTER 60° 17 OG 19 MM HODE

Mutter - kort hode

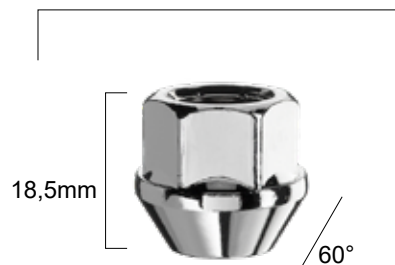

Lukket mutter 60° 17mm Hode	
Gjenge stigning	Varenr
M12x1,5	D90
M12x1,25	D91
M12x1,75	*PF*
M14x1,5	*PF*
M14x2	*PF*
3/8 UNF	*PF*
7/16 UNF	D93
1/2 UNF	D92
9/16 UNF	*PF*

Åpen mutter 60° 17mm Hode	
Gjenge stigning	Varenr
M12x1,5	D95
M12x1,25	D96
M12x1,75	D99
M14x1,5	D95D
M14x2	*PF*
3/8 UNF	*PF*
7/16 UNF	*PF*
1/2 UNF	D97
9/16 UNF	*PF*

Åpen mutter 60° 17mm Hode	
Gjenge stigning	Varenr
M12x1,5	D95RH
M12x1,25	D96RH



Lukket mutter 60° kon 19mm Hode	
Gjenge stigning	Varenr
M12x1,5	D6-ZNNI
M12x1,25	D2-ZNNI
M14x1,50	D13-ZNNI

Lukket mutter 60° 19mm Hode			
Gjenge stigning	Varenr	Gjenge stigning	Varenr
M12x1,5	D6	M12x1,5	D1
M12x1,25	D2	M12x1,25	D3
M12x1,75	*PF*	M12x1,75	D175
M14x1,5	D13	M14x1,5	D5
M14x2	D13X2	M14x2	D5X2
3/8 UNF	D638	3/8 UNF	*PF*
7/16 UNF	D16	7/16 UNF	D7
1/2 UNF	D10	1/2 UNF	D4
9/16 UNF	D6H	9/16 UNF	*PF*

LIVSTIDSGARANTI
M/ RUSTFRI TOPP

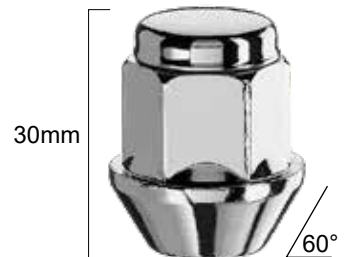

Lukket mutter-60° 19mm Hode m/ rustfritt topp	
Gjenge stigning	Varenr
M12x1,5	D30
M12x1,25	D31
M12x1,75	D35
M14x1,5	D32
M14x2	*PF*
3/8 UNF	*PF*
7/16 UNF	*PF*
1/2 UNF	D33
9/16 UNF	*PF*

Mutter - kort hode

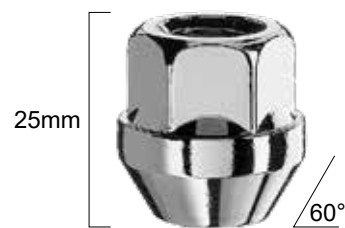

Åpen mutter 60° 19mm Hode	
Gjenge stigning	Varenr
M12x1,5	D60
M12x1,25	D61
M12x1,75	D65
M14x1,5	D62
M14x2	D62X2
3/8 UNF	*PF*
7/16 UNF	D64
1/2 UNF	D63
9/16 UNF	D60H

Åpen mutter 60° 19mm Hode	
Gjenge stigning	Varenr
M12x1,5	D14
M12x1,25	D23
M12x1,75	D1475
M14x1,5	D17
M14x2	D17X2
M14x1,25	D17X125
3/8 UNF	*PF*
7/16 UNF	D14U16
1/2 UNF	D22
9/16 UNF	*PF*

BOLTER OG MUTTERE

MUTTER 60° 21 OG 22 MM HODE

MUTTER 60° - 21 MM HODE



Åpen mutter 60° 21mm Hode	
Gjenge stigning	Varenr
M12x1,5	D21
M12x1,25	D24
M12x1,75	*PF*
M14x1,5	D21D
M14x2	*PF*
3/8 UNF	*PF*
7/16 UNF	*PF*
1/2 UNF	*PF*
9/16 UNF	*PF*

MUTTER 60° - 22 MM HODE



Åpen mutter 60° 22mm Hode	
Gjenge stigning	Varenr
M12x1,5	*PF*
M12x1,25	*PF*
M12x1,75	*PF*
M14x1,5	D18D
M14x2	D18X2
3/8 UNF	*PF*
7/16 UNF	*PF*
1/2 UNF	D18
9/16 UNF	*PF*



MUTTER 60° - 21 MM HODE



Lukket mutter 60° 21mm Hode			
GJENGE STIGNING		VARENR	
M12x1,5	D26	M12x1,5	D8
M12x1,25	*PF*	M12x1,25	D9
M12x1,75	*PF*	M12x1,75	*PF*
M14x1,5	*PF*	M14x1,5	D8D
M14x2	*PF*	M14x2	*PF*
3/8 UNF	*PF*	3/8 UNF	*PF*
7/16 UNF	*PF*	7/16 UNF	*PF*
1/2 UNF	*PF*	1/2 UNF	D15
9/16 UNF	*PF*	9/16 UNF	*PF*

BOLTER OG MUTTERE

MUTTER KULEKON + LANG 17 OG 19 MM HODE

MUTTER KULEKON - 17 OG 19 MM HODE

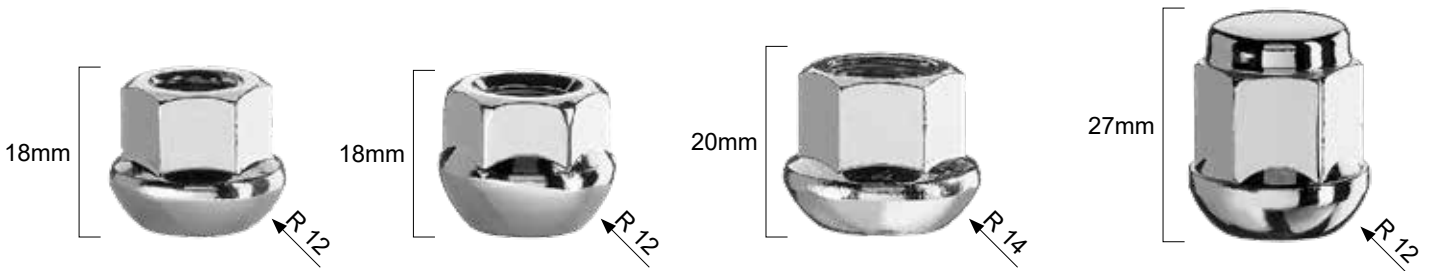

Åpen mutter Kulekon 17mm Hode (Radius 12mm)

Gjenge stigning	Varenr
M12x1,5	D95R
M12x1,25	*PF*
M12x1,75	*PF*
M14x1,5	D95RD
M14x2	D95RX2
3/8 UNF	*PF*
7/16 UNF	*PF*
1/2 UNF	*PF*
9/16 UNF	*PF*

Åpen mutter Kulekon 19mm Hode (Radius 12mm)

Gjenge stigning	Varenr
M12x1,5	D14R
M12x1,25	*PF*
M12x1,75	*PF*
M14x1,5	*PF*
M14x2	*PF*
3/8 UNF	*PF*
7/16 UNF	*PF*
1/2 UNF	*PF*
9/16 UNF	*PF*

Åpen mutter Kulekon 19mm Hode (Radius 14mm)

Gjenge stigning	Varenr
M12x1,5	*PF*
M12x1,25	*PF*
M12x1,75	*PF*
M14x1,5	D17R
M14x2	*PF*
3/8 UNF	*PF*
7/16 UNF	*PF*
1/2 UNF	*PF*
9/16 UNF	*PF*

Lukket mutter Kulekon 19mm Hode m/ rustfritt topp (Radius 12mm)

Gjenge stigning	Varenr
M12x1,5	D30R
M12x1,25	D31R
M12x1,75	D35R
M14x1,5	D32R
M14x2	*PF*
3/8 UNF	*PF*
7/16 UNF	*PF*
1/2 UNF	D33R
9/16 UNF	*PF*

MUTTER 60° - 22 MM HODE

LIVSTIDSGARANTI

M/ RUSTFRI TOPP

Lukket mutter 60° 22mm Hode m/ rustfritt topp

Gjenge stigning	Varenr
M12x1,5	*PF*
M12x1,25	*PF*
M12x1,75	*PF*
M14x1,5	DC22D60
M14x2	DC22D14X2
3/8 UNF	*PF*
7/16 UNF	*PF*
1/2 UNF	*PF*
9/16 UNF	DC22G60



Lukket mutter 60° 22mm Hode m/ rustfritt topp

Gjenge stigning	Varenr
M12x1,5	*PF*
M12x1,25	*PF*
M12x1,75	*PF*
M14x1,5	*PF*
M14x2	*PF*
3/8 UNF	*PF*
7/16 UNF	*PF*
1/2 UNF	*PF*
9/16 UNF	DC22G75



MUTTERE

TORX MUTTER 60°

TORX MUTTER 60° - Ø20 MM

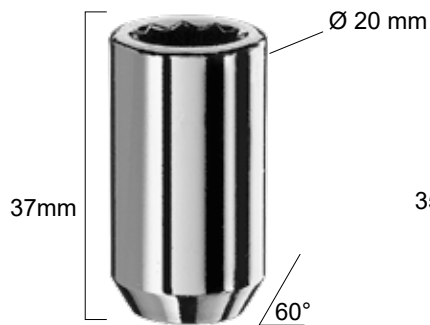

TORX MUTTER 60° - Ø21,6 MM - M/STYRING



Torx Mutter 60° 20mm OD	
Gjenge stigning	Varenr
M12x1,5	DST20A
M12x1,25	DST20B
M12x1,75	DST20G
M14x1,5	DST20D
M14x2	DST20DX2
3/8 UNF	*PF*
7/16 UNF	*PF*
1/2 UNF	DST20E
9/16 UNF	*PF*

Torx Mutter 60° 21,6mm OD m/styring	
Gjenge stigning	Varenr
M12x1,5	DSTC20A
M12x1,25	DSTC20B
M12x1,75	*PF*
M14x1,5	DSTC20D
M14x2	DSTC20DX2
3/8 UNF	*PF*
7/16 UNF	DSTC20F
1/2 UNF	DSTC20E
9/16 UNF	DSTC20H

TORX MUTTER 60° - Ø20 MM

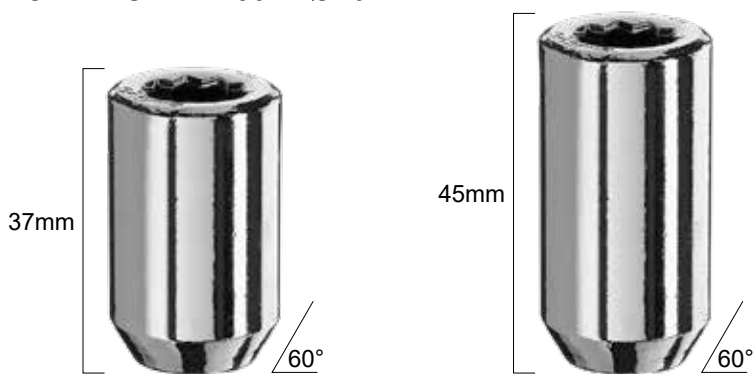

Torx Mutter 60° 23mm OD			
Gjenge stigning	Varenr	Gjenge stigning	Varenr
M12x1,5	DSTA	M12x1,5	DSTA45
M12x1,25	DSTB	M12x1,25	*PF*
M12x1,75	DSTG	M12x1,75	DSTG45
M14x1,5	DSTD	M14x1,5	DSTD45
M14x2	DSTDx2	M14x2	DSTD45X2
3/8 UNF	*PF*	3/8 UNF	*PF*
7/16 UNF	*PF*	7/16 UNF	DSTF45
1/2 UNF	DSTE	1/2 UNF	DSTE45
9/16 UNF	DSTH	9/16 UNF	DSTH45

ADAPTERE TORX

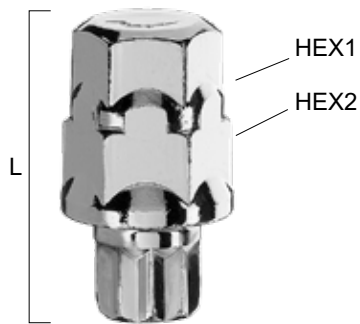

TORX NØKKEL ADAPTER

HEX1	HEX2	L	Varenr
17	19	39	BRST1719



TORX NØKKEL ADAPTER

HEX	L	Varenr
17	70	CSTL17
17	116	CSTL17/116
19	70	CSTL19
21	70	CSTL21

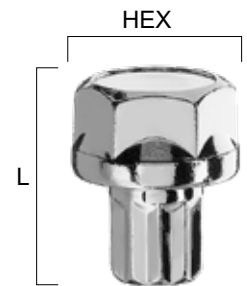

TORX NØKKEL ADAPTER

HEX	L	Varenr
17	30	CST17
19	30	CST19
21	30	CST21



BOLTER

STD BOLTER 60° 17 MM HODE

BOLT 60° 12X1,50

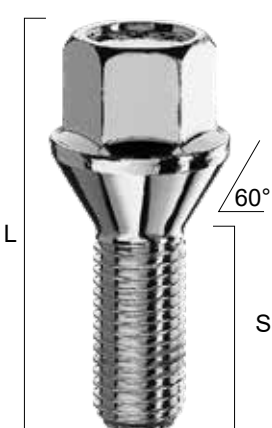

Bolt M12x1,5 60° 17mm Hode		
S	L	Varenr
21	46.5	C17A21
22	47.5	LC17A22F
24	49	B27
26	51.5	B12
28	53.5	C17A28
30	55.5	B30
32	57.5	C17A32
35	60.5	C17A35
37	62.5	C17A37
39	64	B34
42	67.5	C17A42
43	68.5	C17A43
45	70.5	C17A45
47	72	C17A50/47
50	75	C17A50
55	80	C17A55
60	85	C17A60

BOLT 60° 12X1,25

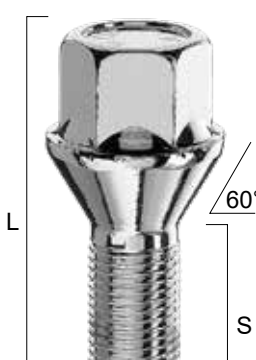

Bolt M12x1,25 60° 17mm Hode		
S	L	Varenr
24	48,5	C17B24
26	50	C17B26
28	52	C17B28
30	54	C17B30
34	58	C17B34
36	60	C17B36
39	64	C17B39
42	67	C17B42
45	70	C17B45
50	75	C17B50
55	80	C17B60/55
60	85	C17B60

BOLT 60° 14X1,50

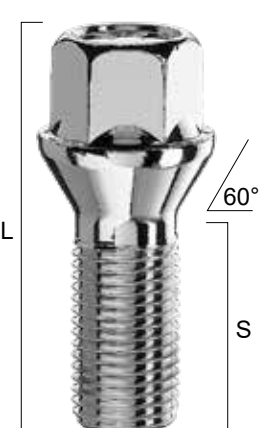

Bolt M14x1,5 60° 17mm Hode		
S	L	Varenr
20	43.5	B46/20
25	48.5	B46
27	51	C17D27
28	52	B13
30	53.5	C17D30
33	56	B42
35	58	C17D35
38	62	C17D40/38
40	63,5	C17D40
43	67	C17D43
45	69	C17D45
47	71	C17D50/47
50	74	C17D50
55	79	C17D60/55
60	84	C17D60

BOLT 60° 14X1,25

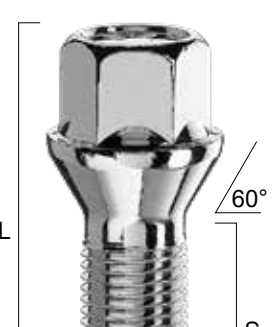

Bolt M14x1,25 60° 17mm Hode		
S	L	Varenr
27,6	51	C17F27
30	53,5	C17F30
33	56,5	C17F33
35	58,5	C17F35
38	61,5	C17F38
40	63,5	C17F40
43	66,5	C17F43
45	68,5	C17F45
50	73,5	C17F50
55	78,5	C17F55

Perfekt for bruk under senterdeksler og ved bruk av skrudde spacere

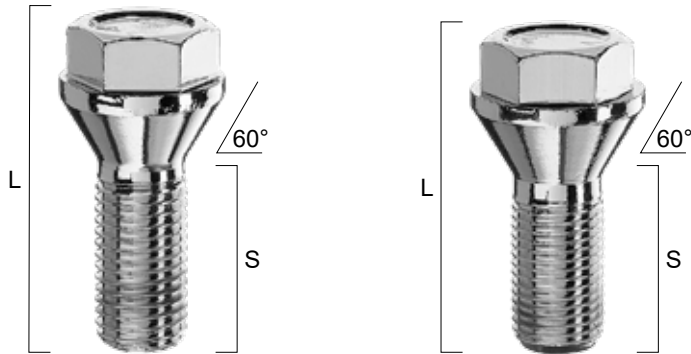

- Det korrekte valget ved montering av skrudde spacere
- Kun 7 mm hodehøyde

Kort hode Bolt M12x1,5 60° 17mm Hode			Kort hode Bolt M12x1,25 60° 17mm Hode		
S	L	Varenr	S	L	Varenr
19	35	C17A19TB	22	41	C17B22TB
20	37,5	C17A21TB			
19	37	C17A21TBEI			
26	42,5	C17A26TB			
26	42,5	C17A26TBEI			

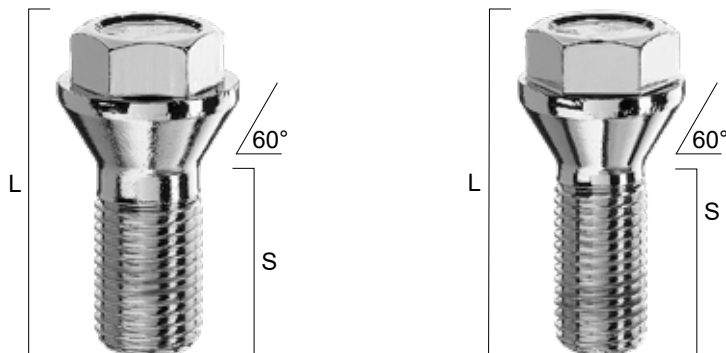

Kort hode Bolt M14x1,5 60° 17mm Hode			Kort hode Bolt M12x1,75 60° 17mm Hode		
S	L	Varenr	S	L	Varenr
19	35,5	C17D19TB	18	37,5	C17G21TB
20	37,5	C17D21TB	22	42,5	C17G26TB
24	40	C17D24TBEI			
24	42	C17D26TB			

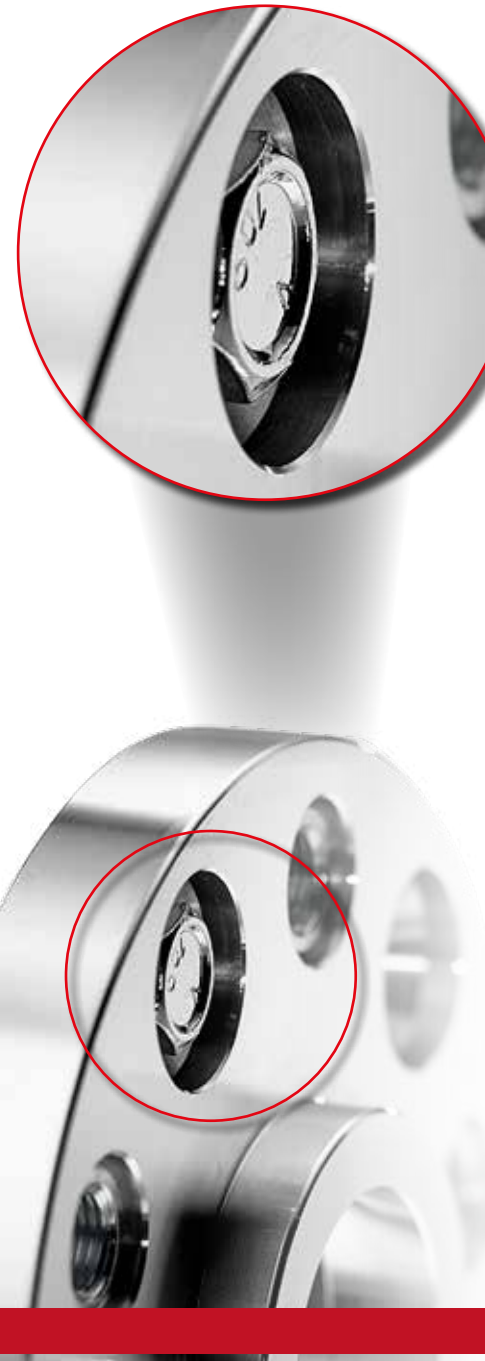

BOLTER

BOLTER FLATT HODE + 60° 19 MM HODE

BOLT FLAT 12X1,25

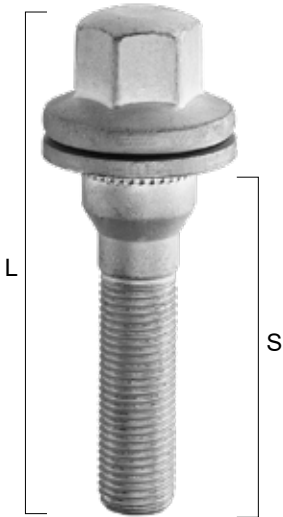

Bolt M12x1,25 Flatt sete 17mm Hode		
S	L	Varenr
35	57	VPE03
40	62	VPE03-40
45	67	VPE03-45
50	72	VPE03-50
55	77	VPE03-55

BOLT FLAT 12X1,50

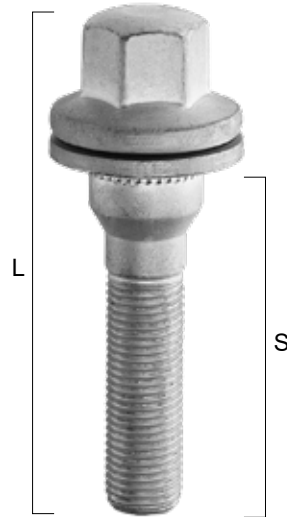

Bolt M12x1,5 Flatt sete 17mm Hode		
S	L	Varenr
32,5	53,5	VPE05
37	59	VPE04-37
43	65	VPE04-43
48	70	VPE04-48
53	75	VPE04-53

BOLT 60° 12X1,50 19 MM

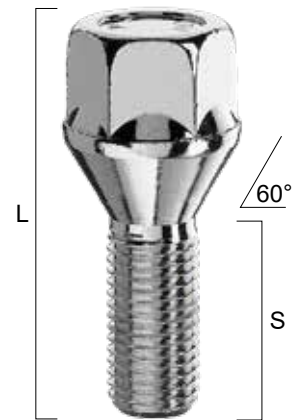

Bolt M12x1,5 60° 19mm Hode		
S	L	Varenr
24	49	C19A24
26	51	B15
50	75	C19A50

BOLT 60° 12X1,75 19 MM

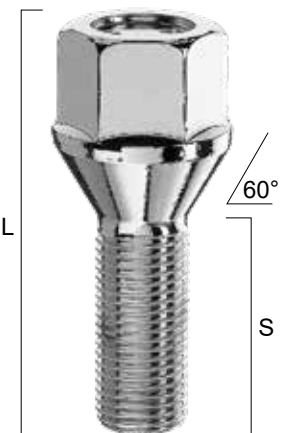

Bolt M12x1,25 60° 19mm Hode		
S	L	Varenr
24	49	C19B24
26	51	C19B26
28	53	B14
32	57	B31
34	59	C19B34
36	61	C19B36
39	64	C19B42/39
42	67	C19B42
46	71	C19B46
50	74	C19B50

BOLT 60° 12X1,75 19 MM

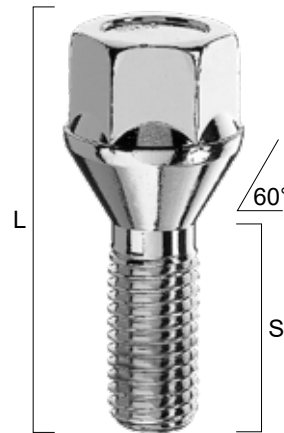

Bolt M12x1,75 60° 19mm Hode		
S	L	Varenr
27	53	VOLVO
35	59,5	C19G35

BOLT 60° 14X1,50
19MM HODE

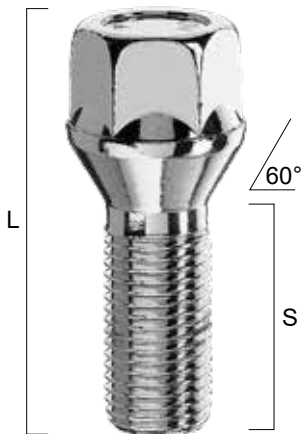

Bolt M14x1,5 60° 19mm Hode		
S	L	Varenr
28	51,5	C19D30/28
30	53,5	C19D30
33	56	C19D36/33
34	57	C19D36/34
36	59	C19D36
50	73	C19D50
69	92	C19D69

BOLT 60° 16X1,50
19MM HODE

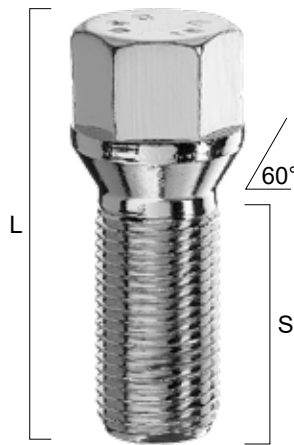

Bolt M16x1,5 60° 19mm Hode		
S	L	Varenr
33	54	2005-02-01

BOLT 60° 14X1,50
LØS KON

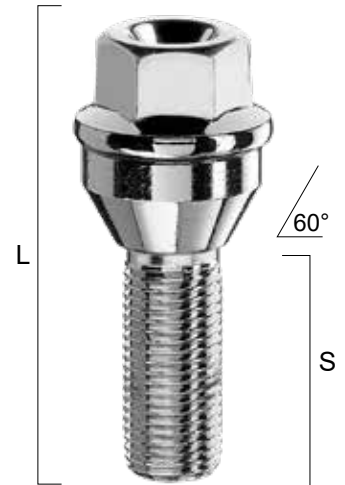

Bolt M14x1,5 60° 19mm Hode		
S	L	Varenr
28	57,5	PC19D28-MW
30	59,5	PC19D30-MW
37	66,5	PC19D37-MW
42	71,5	PC19D42-MW
45	74,5	PC19D45-MW
48	77,5	PC19D48-MW
53	82,5	PC19D53-MW
58	87,5	PC19D58-MW

BOLT 60° 14X1,50 SORT LØS KON

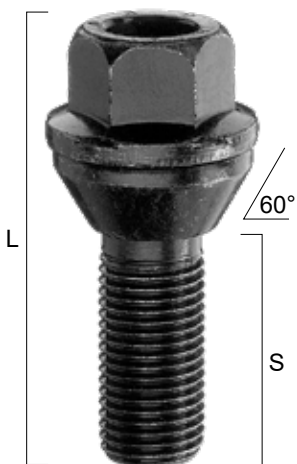

Bolt M14x1,5 60° m/løs kon 19mm Hode		
S	L	Varenr
34	61	C19D34-MW

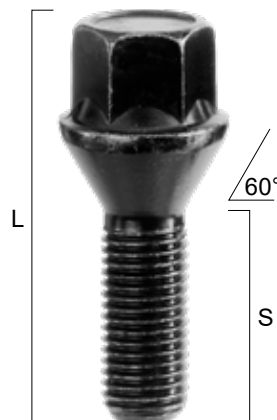

BOLT SORT 60°

Bolt sort 60° kon 17mm Hode		
S	L	Varenr
26	51,5	B12-ZNNI (12X1,50)
28	52	B13-ZNNI (14X1,50)
33	56	B42-ZNNI (14X1,50)

BOLTER

KULEKON R12 - R13 - R14

BOLT 12X1,50 KULEKON 17 MM HODE R12

BOLT 14X1,50 KULEKON 17 MM HODE R12

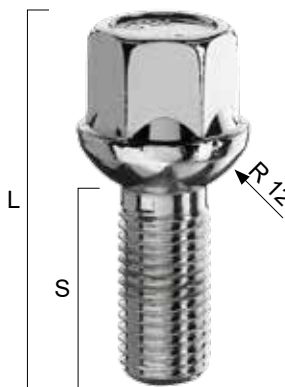

Bolt M12x1,5 Kulekon 17mm Hode (Radius 12 mm)		
S	L	Varenr
21	42,5	LS17A21F
23	42,5	S17A23
26	45,5	S17A26
28	48,5	S17A28
30	50,5	S17A30
32	53,5	S17A32
35	57,5	S17A35
40	60,5	S17A40
45	65	S17A45
50	72,5	S17A50
55	77,5	S17A55
60	81	S17A60

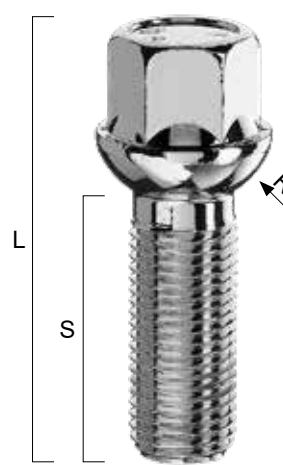

Bolt M14x1,5 Kulekon 17mm Hode (Radius 12 mm)		
S	L	Varenr
25,5	45	LS17D25F
27	47	S17D27
30	51	S17D30
32	53	S17D32
35	56	S17D35
38	59	S17D40/38
40	61	S17D40
43	64	S17D43
45	66	S17D45
47	68	S17D50/47
50	71	S17D50
55	76	S17D60/55
60	81	S17D60
64	85	S17D64

BOLT 14X1,25 KULEKON 17 MM HODE R12 - R13 - R14

NYHET

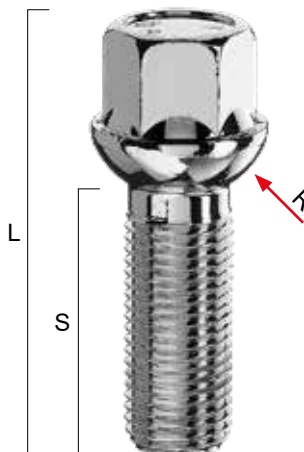

Bolt M14x1,25 Kulekon 17mm Hode				
S	L	R	COATING	Varenr
37	57	12 mm.	DELTAPROTEKT KL100	S17F37-KL100
39	59	12 mm.	WHITE ZINC PLATED	S17F39
29,5	49	13 mm.	DELTAPROTEKT KL100	S17F29-KL100
29,5	49	13 mm.	BLACK ZINC PLATED	S17F29R13ZNNI
29	48	14 mm.	WHITE ZINC PLATED	S17F29R14

BOLT 12X1,50 KULEKON 17 MM HODE R13

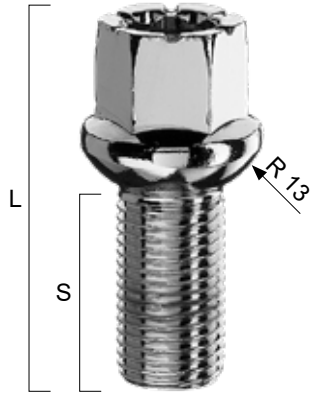

Bolt M12x1,5 Kulekon 17mm Hode Hollow head		
S	L	Varenr
24,5	45,7	LS17A25F-Z

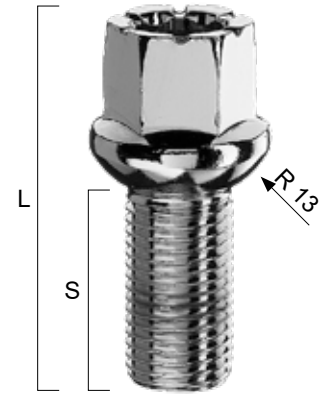

Bolt M14x1,5 Kulekon 17mm Hode Hollow head		
S	L	Varenr
27	48	LS17D27F

Kulekon 17 mm Hode

(Radius 13mm)

BOLT 14X1,50 KULEKON 17 MM HODE R13

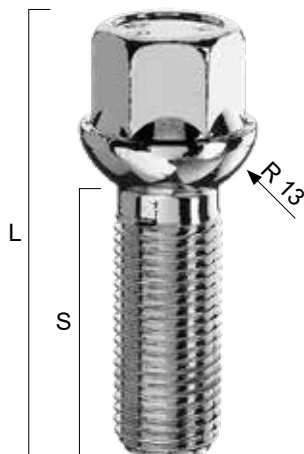

Bolt M14x1,5 Kulekon 17mm Hode		
S	L	Varenr
30	49	S17D30R13
32	51	S17D32R13
35	54	S17D35R13
37	56	S17D37R13
40	59	S17D40R13
43	62	S17D43R13
45	64	S17D45R13
47	66	S17D47R13
50	69	S17D50R13

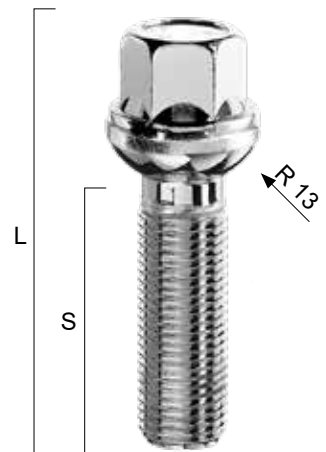

Bolt M14x1,5 17mm Hode W/ SWIVEL WASHER		
S	L	Varenr
32	55,5	S17D32-MW
39	63,5	S17D39-MW
42	65,5	S17D42-MW
48	71,5	S17D48-MW

BOLTER
KULEKON R14

BOLT 14X1,50 KULEKON 17 MM HODE R14

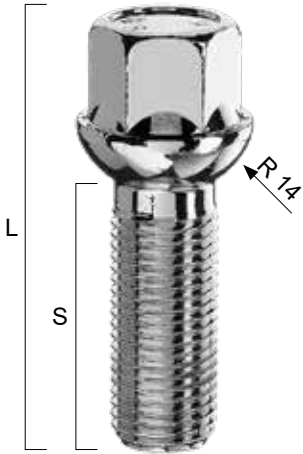

Bolt M14x1,5 Kulekon 17mm Hode		
S	L	Varenr
35	54	S17D45R14/35
40	59	S17D45R14/40
43	62	S17D43R14
45	64	S17D45R14
47	66	S17D47R14
50	69	S17D50R14
55	74	S17D55R14
60	79	S17D60R14
65	84	S17D65R14

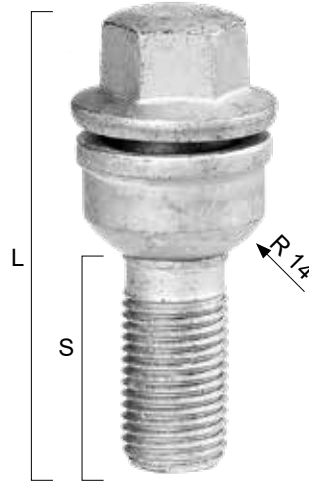

Bolt M14x1,5 Kulekon 17mm Hode W/SWIVEL WASHER		
S	L	Varenr
28	57,5	WS17D28-MW
30	59,5	WS17D30-MW
37	66,5	WS17D37-MW
42	71,5	WS17D42-MW
45	74,5	WS17D45-MW
48	77,5	WS17D48-MW
50	79,5	WS17D50-MW
53	82,5	WS17D53-MW

BOLT 14X1,50 KULEKON 19 MM HODE R14

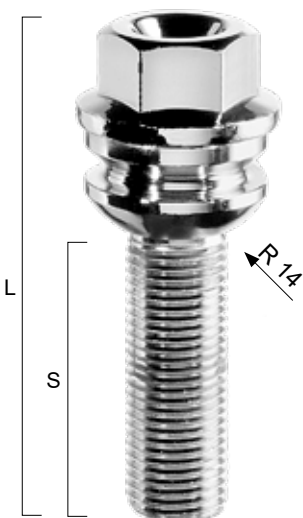

Bolt M14x1,5 Kulekon 19mm Hode W/SWIVEL WASHER		
S	L	Varenr
28	57,5	PS19D28-MW
30	59,5	PS19D30-MW
37	66,5	PS19D37-MW
42	71,5	PS19D42-MW
45	74,5	PS19D45-MW
48	77,5	PS19D48-MW
53	82,5	PS19D53-MW
58	87,5	PS19D58-MW

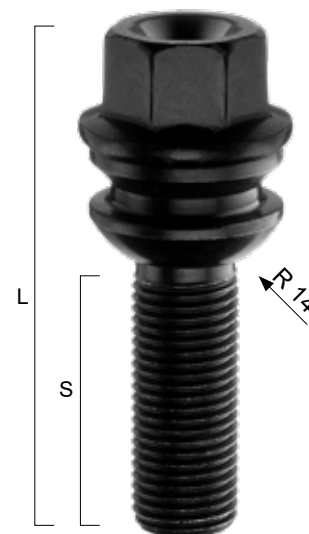

Bolt M14x1,5 Kulekon 19mm Hode W/SWIVEL WASHER		
S	L	Varenr
28	57,5	PS19D28-MW-ZN
30	59,5	PS19D30-MW-ZN
37	66,5	PS19D37-MW-ZN
42	71,5	PS19D42-MW-ZN
45	74,5	PS19D45-MW-ZN
48	77,5	PS19D48-MW-ZN
53	82,5	PS19D53-MW-ZN
58	87,5	PS19D58-MW-ZN

SLINGREBOLTER

VIKTIG MAKS GARANTERT SLINGRING PÅ BOLTSIRKEL 1.2MM (SE TEGNING)

SLINGREBOLTER M/ 19MM HODE							
Varenr	A	B	C	D	E	F	G
B39LE	19	M12x1,25	21	24,5	34,6	26	57
B40LE	19	M12x1,25	21	29,5	39,6	26	62
B39LE/55	19	M12x1,25	37	46	55	26	77,4
SLINGREBOLTER M/ 17MM HODE							
Varenr	A	B	C	D	E	F	G
A39LE-22	17	M12x1,25	18,5	22	32,1	26	54,5
A39LE	17	M12x1,25	21	24,5	34,6	26	57
B48LE	17	M12x1,5	21	27	36,5	26	59
B48LE-30	17	M12x1,5	24	30	39,5	26	62
D39LE	17	M14x1,5	25	27	35	28	58

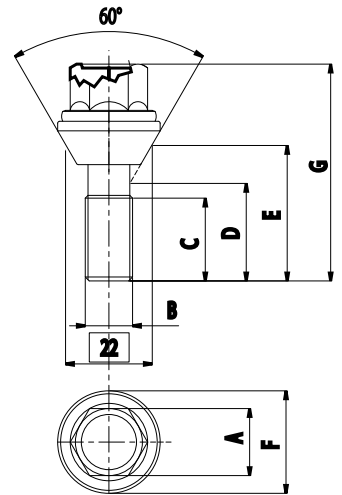

Med dette tilbehøret, kan du bruke en felg for flere applikasjoner. Denne boltens/mutteren, er utstyrt med en mobil konisk skive som holder boltens akse vinkelrett på hjulet, samtidig som det tillates radial forskyvning og en tilhørende PCD-forskyvning.

SLINGREMUTTERE

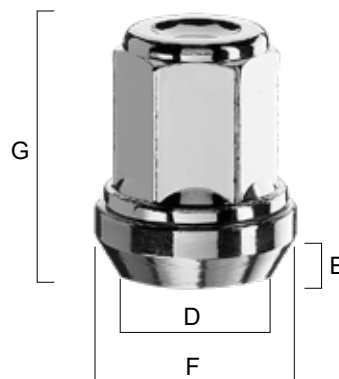
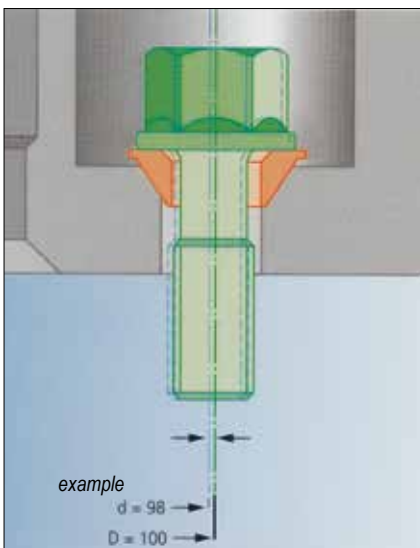

VIKTIG MAKS GARANTERT SLINGRING PÅ BOLTSIRKEL 1.2MM (SE TEGNING)

SLINGREMUTTERE M/ 19MM HODE						
Varenr	Gjenger	Gjenge dybde	D	E	F	G
DV6LE	M12x1,5	26	19	4	26	34
DV2LE	M12x1,25	26	19	4	26	34
DV10LE	1/2 UNF	26	19	4	26	34

BOLTER
TORX BOLTER Ø20 MM

TORX BOLTER 60° - Ø20 MM YTTERDIAMETER

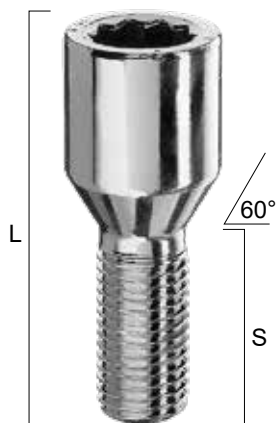

Torx bolt M12x1,5 60° 20mm OD		
S	L	Varenr
22	48	VST20A22
24	50	VST20A24
26	52	VST20A26
28	54	VST20A28
32	58	VST20A32
45	71	VST20A45

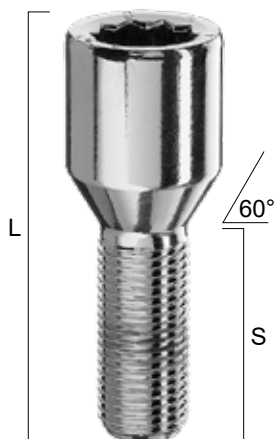

Torx bolt M12x1,25 60° 20mm OD		
S	L	Varenr
24	50	VST20B24
26	52	VST20B28/26
28	54	VST20B28
30	56	VST20B50/30
36	62	VST20B50/36
42	68	VST20B50/42
45	71	VST20B50/45
50	76	VST20B50

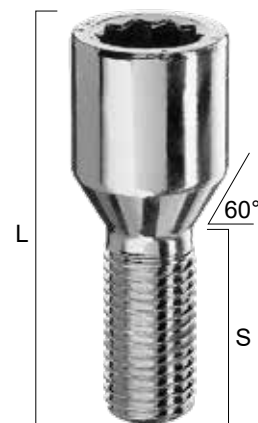

Torx bolt M12x1,75 60° 20mm OD		
S	L	Varenr
28	54	VST20G28
30	56	VST20G30

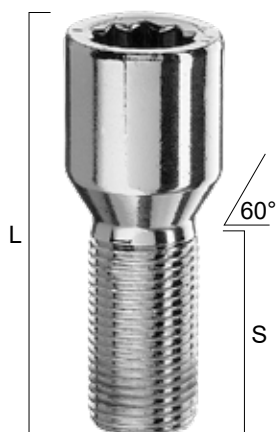

Torx bolt M14x1,25 60° 20mm OD		
S	L	Varenr
27	52	VST20F27
33	57	VST20F50/33
38	62	VST20F50/38
45	69	VST20F50/45
50	74	VST20F50

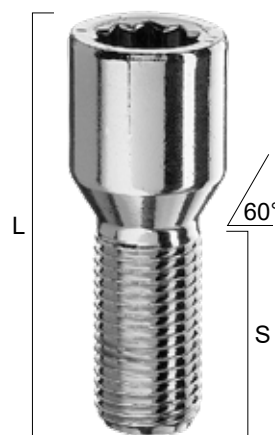

Torx bolt M14x1,5 60° 20mm OD		
S	L	Varenr
25	50	VST20D25
28	53	VST20D28
30	55	VST20D30
33	58	VST20D33
40	65	VST20D40
45	70	VST20D45
55	80	VST20D55

TORX BOLTER 60° - Ø23 MM YTTERDIAMETER

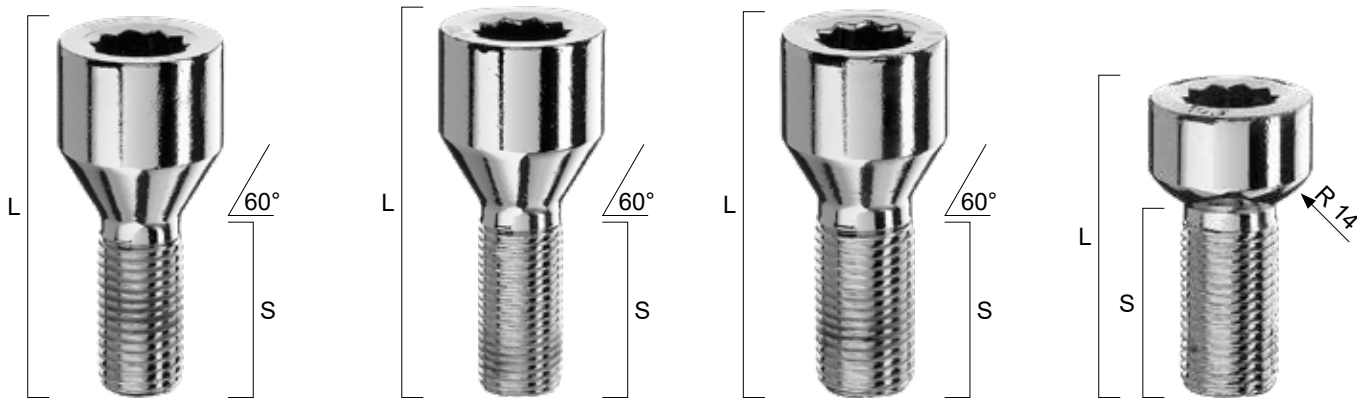

Torx bolt M12x1,5 60° 23mm OD		
S	L	Varenr
24	49,5	VSTA24
26	51,5	VSTA26
28	53,5	VSTA28
32	57,5	VSTA32
40	65,5	VSTA40
42	67,5	VSTA42
52	77,5	VSTA52

Torx bolt M12x1,25 60° 23mm OD		
S	L	Varenr
22	47,5	VSTB22
24	49,5	VSTB24
26	51,5	VSTB26
28	53,5	VSTB28
40	65,5	VSTB40
50	75,5	VSTB50

Torx bolt M14x1,5 60° 23mm OD		
S	L	Varenr
28	53,5	VSTD28
30	55,5	VSTD30
33	58,5	VSTD33
40	65,5	VSTD40
45	70,5	VSTD45
50	75,5	VSTD50
55	80,5	VSTD55

Tuning Torx Bolt M14x1,5 Kulekon 23MM OD		
S	L	Varenr
28	45	VSTD28R14

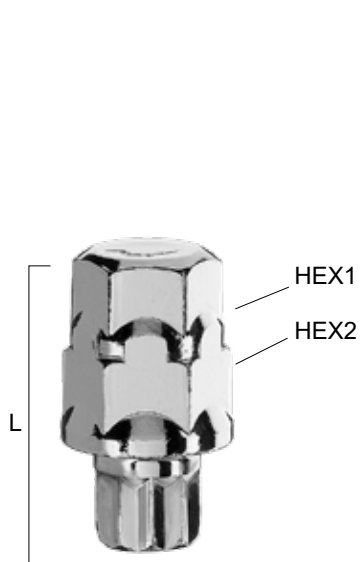

TORX NØKKEL ADAPTER			
HEX1	HEX2	L	Varenr
17	19	39	BRST1719



TORX NØKKEL ADAPTER		
HEX	L	Varenr
17	70	CSTL17
17	116	CSTL17/116
19	70	CSTL19
21	70	CSTL21



TORX NØKKEL ADAPTER		
HEX	L	Varenr
17	30	CST17
19	30	CST19
21	30	CST21

Ytterdiameter

	60.1	63.3	64.0	65.1	66.6	67.1	70.1	71.6	72.6
52.1	AP601521								
54.1	AP601541	AP633541U	AP640541			AP671541			AP726541
56.1	AP601561	AP633561U	AP640561			AP671561		AP716561	AP726561
56.6	AP601566	AP633566U	AP640566			AP671566	AP701566	AP716566	AP726566
57.1	AP601571	AP633571U	AP640571		AP666571	AP671571	AP701571		AP726571
58.1	AP601581	AP633581U	AP640581			AP671581	AP701581		AP726581
58.6		AP633586U				AP671586			
59.1	AP601591	AP633592U	AP640591			AP671591	AP701591		AP726591
59.6							AP701596		AP726596
60.1		AP633602U	AP640601	AP651601		AP671601	AP701601	AP716601	AP726601
63.4				AP651634		AP671634	AP701634		AP726634
64.1						AP671641	AP701641	AP716641	AP726641
65.1					AP666651	AP671651	AP701651		AP726651
66.1						AP671661	AP701661	AP716661	AP726661
66.45							AP7016645		AP726665
66.6							AP701666	AP716666	AN726665
67.1							AP701671	AP716671	AP726671
69.1							AP701691		
69.6									
70.2								AP716703	
70.6								AP716706	
71.5									
72.6									
74.1									
78									
100									
106(.1)									
106,6									
108									

OBS! Vi har ofte flere varianter ringer på lager.
Sjekk vår nettbutikk for fullt sortiment.

TIPS!

Ved søk av ringer i nettbutikk. Søk deler av navn og størrelse.
Bruk mellomrom mellom hver detalj i kategori Felgtilbehør.
Eks: ring 67,1 57,1



4 x 4 - ringer

OZ - Ringer

	73.1	74.1	75	108	110	112	S=68mm	L=75mm	XL=79mm
	AP730521								
	AP731541						OZS-54,06 OZS-54,1		
	AP731561						OZS-56,1	OZL-56,1	
	AP731566						OZS-56,6	OZL-56,56	
	AP731571	AP741571	AN75571				OZS-57,06	OZL-57,06	OZXL-57,06
	AP731581						OZS-58,06	OZL-58,06	
	AP730586								
	AP731591						OZS-59,06		
	AP730596								
	AP731601	AP741601					OZS-60,06 OZS-60,1	OZL-60,1	OZXL-57,06
	AP731634							OZL-63,4	
	AP731641	AP741641						OZL-64,1	OZXL-64,1
	AP731651	AP741651						OZL-65,06	
	AP731661	AP741662						OZL-66,1	OZXL-66,1
	AP731664							OZL-66,46	OZXL-66,46
	AP731666	AP741666						OZL-66,56	OZXL-66,56
	AP731671	AP741671		FLAN108671	FLAN110671			OZL-67,1	OZXL-67,1
	AP731691								
	AP731701 AP731703	AP741701						OZL-70,1 OZL-70,3	OZXL-70,3
								OZL-70,7	OZXL-70,7
	AP731716							OZL-71,56	OZXL-71,56
		AP741726 AN741726						OZL-72,56	OZXL-72,56
								OZL-74,06	OZXL-74,1
				FLAN10878					
				FLAN108100	FLAN110100				
					FLAN110106	FLAN1121061			
					FLAN1101061				
					FLAN110108				

AN+Varenr = Aluminiumsring
AP+Varenr = Plastring



OM SPACERE

Hvorfor spacere?

Utseende - En ønsker av og til presse hjulene helt ut mot skjermkantene for å få et penere, eller kanskje et mer aggressivt utseende.

Klaring - Noen felger er ikke alltid kompatible med store bremsesett. Bremsecaliper vil kanskje "subbe" i eikene på felgen, og spacere er nødvendig for å få klaring.

Stabilitet - Ved større hjulavstand, kan en gjøre bilen mer stabil på svingete vei, omtrent som å påmontere bredere dekk.

Hvilken tykkelse?

Det mest stilte spørsmålet, men dessverre ingen fasit svar på; Det å finne en spacer som dekker alle behov, er ikke så lett som det høres ut.

Det finnes flere ulike grunner til å benytte spacere, så hver situasjon kan få forskjellig resultat.

Norgesdekk AS

- anbefaler i utgangspunktet ikke bruk av spacere, men av og til er man nødt for at en i hele tatt skal få montert hjulene på bilen.

Vi har nå tatt inn de mest etterspurte spacere til lager.

Etterspørselen hos oss er størst på BMW, Mercedes og VW/Audi.

Legg merke til at vi har fått spesialprodusert 20mm BMW spacer til bruk på X6.

Alle våre spacere er sentrert på nav. OBS! 5mm spacere er uten utvendig "leppe" for sentrering på felg.



HUSK LENGRE BOLTER VED BRUK AV SPACERE

BIMECC SPACERE - ITALIENSK KVALITET

Bimecc Spacere						
Varenr	Boltsirkel	Tykkelse	Ø Innv	Ø Utv	Sentrert	Anmerkning
BISPB100	5x112	20mm	66,6	66,6	JA	
BISPB110	5x112	10mm	66,6	66,6	JA	Passer til lange MB nav. eks C202
BISPB141	5x108	25mm	65,1	65,1	JA	PINB+M12150SO
BISPB150	4/5x108	20mm	65,1	65,1	JA	
BISPB40B	4/5x100	25mm	57,1	57,1	JA	
BISPB4216	4/5x100	15mm	57,1	57,1	JA	
BISPB4POR	5x130	4mm	71,6	71,6	JA	
BISPB5100112	5x100/5x112	5mm	57,1	57,1	JA	
BISPB510820634	5x108	20mm	63,4	63,4	JA	Sort M/PIB+M12150SO
BISPB511420641	5x114,3	20mm	60,1	64,1	JA	Sort + SR6460
BISPB511420716	5x114,3	20mm	67,1	71,6	JA	Sort + SR7167
BISPB511425661	5x114,3	25mm	66,1	66,1	JA	Sort PINB12125
BISPB512015726	5x120	15mm	72,6	72,6	JA	Sort
BISPB51202574	5x120	25mm	72,6	72,6	JA	Sort MB14125
BISPB513015PORB	5x130	15mm	71,6	71,6	JA	Sort
BISPB513020POR	5x130	20mm	71,6	71,6	JA	Sort
BISPB513025PORB	5x130	25mm	71,6	71,6	JA	Sort
BISPB513030PORB	5x130	30mm	71,6	71,6	JA	Sort
BISPB545100	4/5x100	5mm	57,1	57,1	JA	
BISPB545100T	4/5x100	5mm	54,1	54,1	JA	
BISPB545108	4/5x108	5mm	65,1	65,1	JA	
BISPB545108F	4/5x108	5mm	63,4	63,4	JA	
BISPB545114	4/5x114,3	5mm	67,1	67,1	JA	
BISPB54598	4/5x98	5mm	58,1	58,1	JA	
BISPB55108R	5x108	5mm	60,1	60,1	JA	
BISPB55120B	5x120	5mm	74,1	74,1	JA	
BISPB5598108	5x98/108	5mm	58,1	58,1	JA	
BISPB66139	6x139,7	6mm	110	110	Nei	
BISPB7POR	5x130	7mm	71,6	71,6	JA	
BISPB80D	5x120	15mm	72,6	72,6	JA	
BISPB85F	5x120	20mm	72,6	72,6	JA	
BISPB86	5x120	10mm	74,1	74,1	JA	
BISPB90B	5x112/5x100	25mm	57,1	57,1	JA	
BISPB90D	5x100/5x112	12,5mm	57,1	57,1	JA	



ATHENA SPACERE - ITALIENSK KVALITET

Athena Spacere						
Varenr	Boltsirkel	Tykkelse	Ø innv	Ø Utv	Sentrert	Anmerkning
ATEO-P0507S	5x120	5mm	72,6	72,6	Nei	
ATEO-P0516S	5x112	5mm	66,5	66,5	Nei	
ATEO-P0519S	4x100	5mm	60,1	60,1	Nei	
ATEO-P1206S	5x112	12mm	57,1	57,1	Ja	
ATEO-P1207S	5x120	12mm	72,6	72,6	Ja	
ATEO-P12131S	5x120	12mm	64,1	64,1	Ja	Tesla S
ATEO-P1216S	5x112	12mm	66,5	66,5	Ja	
ATEO-P1218S	4x108	12mm	65,1	65,1	Ja	
ATEO-P1226S	4x100	12mm	57,1	57,1	Ja	
ATEO-P1269S	5x120	12mm	74,1	74,1	Ja	
ATEO-P1525S	3x112	15mm	57,1	57,1	Ja	
ATEO-P1606S	5x112	16mm	57,1	57,1	Ja	
ATEO-P1607S	5x120	16mm	72,6	72,6	Ja	
ATEO-P1616S	5x112	16mm	66,5	66,5	Ja	
ATEO-P1631S	5x108	16mm	65,1	65,1	Ja	
ATEO-P1661S	5x108	16mm	63,4	63,4	Ja	
ATEO-P1663S	5x120	16mm	65,1	65,1	Ja	
ATEO-P1669S	5x120	16mm	74,1	74,1	Ja	
ATEO-P1740S	5x110	17mm	65,1	65,1	Ja	
ATEO-P2006S	5x112	20mm	57,1	57,1	Ja	
ATEO-P2007S	5x120	20mm	72,6	72,6	Ja	
ATEO-P2012CD	4x108	20mm	63,4	63,4	Ja	SKRUDD PINB+M12150SO
ATEO-P2016S	5x112	20mm	66,5	66,5	Ja	
ATEO-P2025S	3x112	20mm	57,1	57,1	Ja	
ATEO-P2026S	4x100	20mm	57,1	57,1	Ja	
ATEO-P2027S	5x100	20mm	57,1	57,1	Ja	
ATEO-P2037S	5x130	20mm	71,6	71,6	Ja	
ATEO-P2053CD	5x114,3	20mm	66,1	66,1	Ja	SKRUDD
ATEO-P2056CD	5x114,3	20mm	67,1	67,1	Ja	SKRUDD
ATEO-P2061CD	5x108	20mm	63,4	63,4	Ja	SKRUDD PINBOLT+M12150SO
ATEO-P2061S	5x108	20mm	63,4	63,4	Ja	
ATEO-P2063S	5x120	20mm	65,1	65,1	Ja	
ATEO-P2067CD	5x114,3	20mm	60,1	60,1	Ja	SKRUDD
ATEO-P2069S	5x120	20mm	74,1	74,1	Ja	
ATEO-P2087CD	5x108	20mm	63,4	63,4	Ja	SKRUDD PINBOLT+M14150SO
ATEO-P2524CD	5x112	25mm	66,6	66,6	Ja	SKRUDD
ATEO-P2526CD	4x100	25mm	57,1	57,1	Ja	SKRUDD
ATEO-P2537CD	5x130	25mm	71,6	71,6	Ja	SKRUDD PINB+M14150SO
ATEO-P3024CD	5x112	30mm	66,6	66,6	Ja	SKRUDD
ATEO-P3026CD	4x100	30mm	57,1	57,1	Ja	SKRUDD
ATEO-P3037CD	5x130	30mm	71,6	71,6	Ja	SKRUDD PINB+M14150SO
ATEO-P3053CD	5x114,3	30mm	66,1	66,1	Ja	SKRUDD
ATEO-P3061CD	5x108	30mm	63,4	63,4	Ja	SKRUDD PINB+M12150SO
ATEO-P3069CD	5x120	30mm	74,1	74,1	Ja	SKRUDD
ATEO-P3087CD	5x108	30mm	63,4	63,4	Ja	SKRUDD PINB+M14150SO
ATEO-P5025CD	3x112	50mm	57,1	57,1	Ja	SKRUDD m/10mm unbrako innfesting
ATEO-PFST230	6x139,7	30mm	106,2	106,2	Ja	PINB+M12150SO19
ATEO-PFST235	6x139,7	35mm	106,2	106,2	Ja	PINB+M12150
ATEO-PNFSM430	5x130	30mm	84,1	84,1	Ja	PINB+M14150RO

Norgesdekk Spacere						
Varenr	Boltsirkel	Tykkelse	Ø innv	Ø Utv	Sentrert på felg	Veil
NDSP51205726	5x120	5m	72,6mm	72,6mm	Nei	295,-
NDSP512010726	5x120	10mm	72,6mm	72,6mm	Ja	445,-
NDSP512015726	5x120	15mm	72,6mm	72,6mm	Ja	465,-
NDSP512020726	5x120	20mm	72,6mm	72,6mm	Ja	495,-
NDSP512010741	5x120	10mm	74,1mm	74,1mm	Ja	445,-
NDSP5120207274 ***	5x120	20mm	72,6mm	74,1mm	Ja	495,-
NDSP511212665	5x112	12mm	66,5mm	66,5mm	Ja	455,-
NDSP511215665	5x112	15mm	66,5mm	66,5mm	Ja	465,-
NDSP511220665	5x112	20mm	66,5mm	66,5mm	Ja	495,-
NDSP51001125571	5x100/112	5mm	57,1mm	57,1mm	Nei	295,-
NDSP510011210571	5x100/112	10mm	57,1mm	57,1mm	Ja	445,-

*** Spesielspacer BMW X6 (E71) - for å bruke 74,1 felger både foran og bak ***

OBS! Sjekk at nav ikke er for stort på 10mm 5x100/112 spacer. Enkelte VAG har 15mm nav. Da vil disse ikke passe.

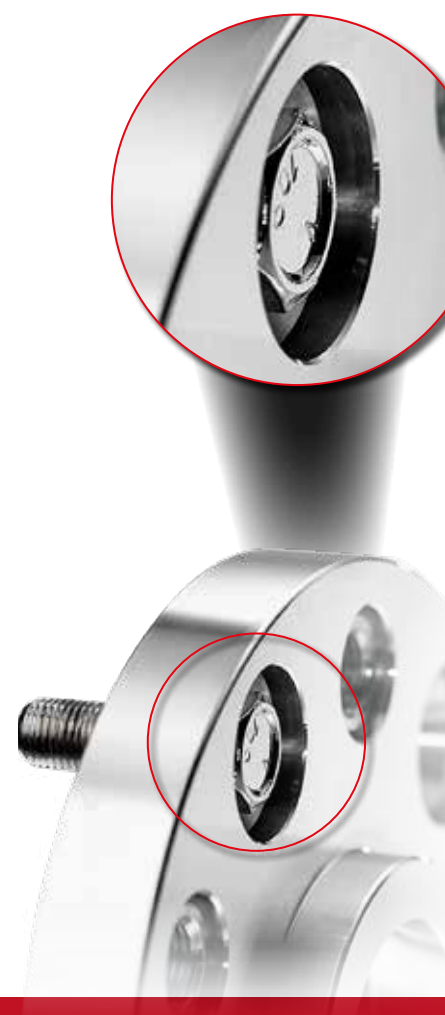

BOLTER OG MUTTERE

OE TILBEHØR

Bimecc®

Bimecc tilbyr en rekke bolter og muttere til originale aluminium og stålfelger.



















Norgesdekk lagerfører flere av disse.



Bilmerke	Side
ALFA ROMEO	39
AUDI	39
BMW	39-40
CHEVROLET	40
CITROËN	40-42
DACIA	42
DAIHATSU	42
FIAT	42-43
FORD	43-44
HONDA	44-45
HYUNDAI	45
LANCIA	45
LAND ROVER	45
MAZDA	46
MERCEDES	46-47

Bilmerke	Side
MINI	47
MITSUBISHI	47
NISSAN	48
OPEL	48
PEUGEOT	49-50
PORSCHE	50-51
RENAULT	51
SEAT	51
SKODA	52
SMART	52
SUZUKI	52
TESLA	52
TOYOTA / LEXUS	53
VOLKSWAGEN	54
VOLVO	55

BOLTER OG MUTTERE OE TILBEHØR

BILDE	BILTYPE – TYPE			Felgtype 	TEKNISKE Detaljer	OEM VARE#	BIMECC VARE#
ALFA ROMEO							
	147 (937) 156 (932) 166 (936)	GT (937) Giulietta (940)	Mito (955)		Konisk 60° K 17M12x1,25x22/48,5 8.8 Deltaprotekt KL100	132 304 25	IBS13230425
	159 (939) Brera (939) Spider (939)				Konisk 60° K 17 M14x1,5x25/49 10.9 Deltaprotekt KL100	606 974 42 606 941 02	B46-KL100
AUDI							
	Audi 80 (81) Audi Coupe (85 from chassis C-000 001) A2 (14" rims only)				Kulekon R13 K 17 M12x1,5x24,5/45,7 10. 9 White Zincplated	3A0 601 139	LS17A25F-Z
	A1 (8X) A2 (8Z except 14" rims) A3 (8L, 8P, 8V) A4 (B8, QB6, 8E, 8H, B5, 8K) A5 Sportback (B8)	200 (43, 44, C4) V8 (D11) Coupe (85, 8B) TT (8J, 8N) A6 (4B, 4F, 4G)	A7 Sportback (4G) A8 (D2, Q2, 4E, 4H) 80 (89, 89Q, B4) 100 (43, 44, C4)		Kulekon R13 K 17 M14x1,5x27/47,5 10. 9 White Zincplated	WHT 002 437	LS17D27F
	A4 Cabrio (8H) S4 (8E) A5 Cabrio (B8) S5 S5 Cabrio RS5 (B8)	A6 (4F) A6 Allroad (4B) A6 quattro (4F, 4G) A6 cabrio (4F2, 4F5) S6	RS6 (4B, 4F, 4G) A8 (4D from '01) A8 Quattro (8D from '01) S8 TT (8N)		Kulekon R13 K 17 M14x1,5x27/51 (2 pcs.) 8.8 White Zincplated	4D0 601 139A	LS17D27F-MW2
	A8 (4H only armoured cars) Q3 (8U) Q5 (8R) Q7 (4M)				Kulekon R14 K 17 M14x1,5x30/59,5 (2 pcs.) 10.9 Deltaprotekt KL100	8R0 601 295	WS17D30-MW
	Q7 (4L)				Kulekon R14 K 19 M14x1,5x37/67 (2 pcs.) 10.9 White Zincplated	7L0 601 139A	PS19D37-MW
BMW							
	1 series (E81, E87, E88) 3 series (E21, E30, E36, E46, E90, E91, E92, E93)	5 series (E12, E28, E34, E39, E60, E61) 6 Series (E24) 7 series (E23-E32-E38) 8 series (E31)	Z1 (E30) Z3 (E36) Z4 (E85, E86, E89) Z8 (E52)		Konisk 60° K 17 M12x1,5x26/51 8.8 Corrolube	36 13 1 126 191 36 13 6 781 150	B12PI
	5 serie (E12)				Konisk 60° K 19 M12x1,5 8 Zincplated + s/s cap	36 13 1 113 132	D30

BOLTER OG MUTTERE OE TILBEHØR

BILDE	BILTYPE - TYPE			Felgtype  	TEKNISKE Detaljer	OEM VARE#	BIMECC VARE#
BMW							
	X5 serie (E53)				Konisk 60° K 17 M14x1,5x32/44/58 (2 pcs.) 10.9 Black Zincplated	36 13 6 781 153	C17D31F-MW
	1 serie (F20, F21) 2 serie (F22, F23, F45, F46) 3 serie (F30, F31,F34,F35) X3 serie (F25)	4 serie (F32, F33, F36) 5 serie (F10, F11, F18) X4 serie (F26) X5 serie (E70, F15, F85) X6 (E71, E72,F16)	6 serie (F06, F12, F13) 3GT (F34, F35) 5GT (F07) 7 Series (F01, F02, F03, F04, G11, G12)	 	Konisk 60° K 17 M14x1,25x27/46,3 8.8 Corrolube	36 13 6 781 151	C17F27PI2
CHEVROLET							
	Spark Matiz				Konisk 60° K 17 M12x1,25 8 White Zincplated	94515470 94515410	D96
	Aveo (KLAS, KL1T) Trax (KL1B) Orlando (KL1Y) Cruze (KL1J)				Konisk 60° K 19 M12x1,5 10 Zincplated + s/s cap	09594682	DGM01
CITROËN							
	Berlingo 2 and 3 C2 (J) C3 (F,H,S)	C4 Cactus (0) C4 (L) C5 (D, R9) C6 (T)	Jumpy (270) Saxo (S0, S1)		Flat K 17 M12x1,25x17/57 (2 pcs.) 10.9 Deltaprotekt KL100	5405.67	VPE03
	AX (ZA) Saxo (S0, S1) Xantia (X1, X2)	Xsara (N6) Xsara Picasso (C)			Flat K 19 M12x1,25x17/63 (2 pcs.) 10.9 White Zincplated	5405.35	VPE01-ZB
	Berlingo (7, TU) Berlingo 3 Tepee (TU) C4 (L, N) C4 Cactus (0)	C4 coupè (L) C4 Picasso (U) C4 Grand Picasso (U) DS5 (K, KF)	DS4 (N) C5 (6FZ, R) Jumpy 3 (270)		Konisk 60° K 17 M12x1,25x26/49 (2 pcs.) 10.9 Deltaprotekt KL100	5405.72 16 087 344 80	C17B24-MW
	AX (ZA) Berlingo (NFU) Saxo (S0, S1)	Xsara (N6) Xsara Picasso (C) Xantia (X1, X2)			Konisk 60° K 19 M12x1,25x26/52 10.9 White Zincplated	5405.55	C19B26
	Berlingo (7, MF) Berlingo 3 Tepee (TU) C2 (JM) C3 (FC, S, HB)	C3 Picasso (SH) DS3 (S) DS4 (N) C4 (B7, LA, LC)	C6 (TD) Nemo (A) Jumpy 3		Konisk 60° K 17 M12x1,25x26/47 10.9 Deltaprotekt KL100	5405.66	B0400-001

BOLTER OG MUTTERE OE TILBEHØR

BILDE	BILTYPE – TYPE	Felgtype 	TEKNISKE Detaljer	OEM VARE#	BIMECC VARE#
	C1 (PM, PN)		Konisk 60° K 17 M12x1,5x21/42 10.9 White Zincplated	5405.77	C17A21
	C1 (PM, PN)		Flat K 17 M12x1,5x35/59,5 (2 pcs.) 10.9 Deltaprotekt KL100	5405.80	PZ406-9068000
	C1 (580W)		Flat K 17 M12x1,5x33/53,5 (2 pcs.) 10.9 Deltaprotekt KL100	5405.85	VPE05
	Jumper (230 e 244). Axial load from 1,1 - 1,4 Ton.		Konisk 60° K 24 M14x1,5x28,2/53 10.9 Deltaprotekt KL100	5405.75	B0046-003
	Jumper (230 e 244). Axial load from 1,8 Ton.		Konisk 60° K 24 M16x1,5x31/57 10.9 Deltaprotekt KL100	5405.76	B0046-004
	C8 (E)		Konisk 60° K 17 M14x1,5x26/56,5 (2 pcs.) 10.9 Deltaprotekt KL100	5405.69	B0046-002
	C8 (E) Jumpy (B up to '06)		Konisk 60° K 17 M14x1,5x25/56,5 10.9 Deltaprotekt KL100	5405.68	B0046-001
	Jumper (250). Axial load from 1,1 - 1,7 Ton.	 (15" only)	Konisk 60° K21 M14x1,5x27/62 10.9 Deltaprotekt KL100	5405.78	B0046-006
				5405.88	
	Jumper (250). Axial load from 1,6 Ton.	 (16" only)	Konisk 60° K 21 M16x1,5x29/64 10.9 Deltaprotekt KL100	5405.79	B0046-007
	C-Crosser (V) C Zero (1) C4 Aircross (B)		M12x1,5x42/47 Knurl Ø 14,3 Head Ø 18 10.9 White Zincplated	3714.28	CRP143A42

BOLTER OG MUTTERE OE TILBEHØR

BILDE	BILTYPE - TYPE			Felgtype 	TEKNISKE Detaljer	OEM VARE#	BIMECC VARE#
CITROËN							
	C-Crosser (V) C Zero (1) C4 Aircross (B)				Konisk 60° K 21 M12x1,5 8 Yellow Zincplated	5405.81	DMTSB
	C-Crosser (V) C Zero (1) C4 Aircross (B)				Flat K 21 M12x1,5 (2 pcs.) 8 Chromeplated	5405.82	DTOY01
DACIA							
	Dokker (SD) Duster (SD) Logan (SD, SR) Sanderø (SD, SR) Lodgy (SD)				Konisk 60° K 17 M12x1,5x26/51 10.9 White Zincplated	82 00 473 353 82 00 610 460 40 22 22 121R	B12
DAIHATSU							
	Charade (XP9F) Cuore (L2, L27) Materia (M4) Sirion (M3)				Konisk 60° K 21 M12x1,5 8 Yellow Zincplated	90942-01007	DMTSB
FIAT							
	500 (312) 500C (312) 500L (199) 500X (334) Bravo 2 (198)	Doblò (119, 152) Doblò Cargo (223, 263) Idea (135, 350) Linea (323) Multipla (186)	Panda 2 (169) Panda 3 (312) Stilo (192) Qubo (225)		Konisk 60° K 17 M12x1,25x22/ 48,5 8.8 Deltaprotekt KL100	13.230.425	IBS13230425
	Barchetta (183) Cinquecento (170) Panda 1 (141) Punto 1 (176)	Punto 2 (188) Seicento (187) Uno (146)			Konisk 60° K 19 M12x1,25x27/42 8.8 Deltaprotekt KL100	13.228.924	IBS13228924
	Croma (194) Grande Punto (199) Punto Evo (199) Punto 2013 (199) Sedici (FY)				Konisk 60° K 17 M12x1,5x22/47,5 10.9 White Zincplated	51.732.885	LC17A22F
	Scudo (220) Ulysse (179)				Konisk 60° K 17 M14x1,5x25/56,5 10.9 Deltaprotekt KL100	1.493.974.080	B0046-001
	Scudo (270 da 11/2007)				Konisk 60° K 17 M12x1,25x26/49 (2 pcs.) 10.9 Deltaprotekt KL100	9.634.648.980	C17B24-MW

BOLTER OG MUTTERE OE TILBEHØR

BILDE	BILTYPE - TYPE	Følgtype 	TEKNISKE Detaljer	OEM VARE#	BIMECC VARE#		
FIAT							
	Scudo (270 fom 11/2007)		Flat K 17 M12x1,25x17/57 (2 pcs.) 10.9 Deltaprotekt KL100	9.644.576.680	VPE03		
	Ducato (230, 244). Axial load from 1,1 - 1,4 Ton.		Konisk 60° K 24 M14x1,5x28,2/53 10.9 Deltaprotekt KL100	1.345.713.080	B0046-003		
	Ducato (230, 244) Axial load from 1,8 Ton.		Konisk 60° K 24 M16x1,5x31,6/57 10.9 Deltaprotekt KL100	1.345.714.080	B0046-004		
	Ducato (250) Axial load from 1,1 - 1,7 Ton.	 (15" only)	Konisk 60° K 21 M14x1,5x27/62 10.9 Deltaprotekt KL100	1.363.349.080 1.351.202.080	B0046-006		
	Ducato (250) Axial load from 1,6 Ton.	 (16" only)	Konisk 60° K 21 M16x1,5x29/64 10.9 Deltaprotekt KL100	1.351.203.080	B0046-007		
FORD							
	KA 2 (RU8)		Konisk 60° K 17 M12x1,25x22/48,5 8.8 Deltaprotekt KL100	1 559 373	IBS13230425		
	B-Max (JK8) Ka (RBT) Escort (ATO, GTO) Fiesta (GFJ, JAS, JH1, JA8)	Focus (DAW, DA3, DYB) Fusion (JU2) Grand C-Max (DM2, DXA) Kuga (DM2)	Mondeo (GBP, B4Y, BA7) Puma (ECT) Scorpio (GFR, GGR)		6.040.307 5.114.405 1.007.487	D60FB	
	C-Max (DM2, DXA) Fiesta (GJF, JAS, JH1, JA8) Focus (DAW, DA3, DYB)	KA (RBT) Kuga (DM2) Mondeo (L1F, L1J) Puma (ECT)			Knurl Ø 13,0 Head Ø 18 M12x1,5x42 10.9 White Zincplated	1.473.166 1.470.843	CRP130A42
	B-Max (from 01/2012) Fiesta (from 05/2012) C-Max (from 01/2012) Grand C-Max (from 01/2012) Focus (from 11/2012)	Ecosport Mondeo (from 02/2015) Tourneo Courier (from 02/2012) Tourneo Connect (from 11/2013)	Kuga (from 10/2012) Transit Courier (from 09/2013) Transit Connect (from 02/2015)		Konisk 60° K 19 M12x1,5 10 Zincnickel + s/s cap	5.114.407	DF04
	B-Max (JK8) C-Max (DM2, DXA) Cougar (BCV) Fiesta (J5S, JVS, JD3, JH1, JC3, JA8, JR8)	Focus (DA3, DB3, DYB, DAW, DBW) KA (RBT) Fusion (JU2)	Kuga (DM2) Mondeo (BA7, B4Y, B5Y)		Konisk 60° K 19 M12x1,5 10 Zincplated + s/s cap	6.111.766 1.454.051	DF02N

BOLTER OG MUTTERE OE TILBEHØR

BILDE	BILTYPE - TYPE	Felgtype	TEKNISKE DETALJER	OEM VARE#	BIMECC VARE#		
	C-Max (DM2, DXA) Cougar (BCV) Fiesta (J5S, JVS, JD3, JH1, JC3, JA8, JR8)	Focus (DA3, DB3, DYB, DAW, DBW) KA (RBT) Kuga (DM2)	Mondeo (BA7, B4Y, B5Y)	 (With Cap)	Konisk 60° K 19 M12x1,5 10 Zincnickel	6.652.292 1 454 053	DF01N
	Galaxy (WGR from 1995 to 2000)				Kulekon R14 K 19 M14x1,5x34/66 10.9 Black Zincplated	7.201.016	LS19D34F
	Galaxy (WGR from 2000 to 2007)				Kulekon R14 K 19 M14x1,5x34/62 (2 pcs.) 10.9 Deltaprotekt KL100	1.126.877	LS19D34F-MW
	Galaxy (WA6 from 2006 to 2011) S-Max (WA6 from 2006 to 2011)				Konisk 60° K 21 M14x1,5 10 Deltaprotekt KL100	1 377 748	D62F
	Galaxy (WA6 from 2006 to 2011) S-Max (WA6 from 2006 to 2011)				Konisk 60° K 21 M14x1,5 10 Zincplated + s/s cap	1.428.137 1.377.747	DF03
	Transit 2000-2006 (FBEY/DEY/DFY/DGY/MEY/MFY/NFY/SEY/SFY/SGY/ ZEY/AEY/AFY/AGY) Transit 2006-2011 (FAE6/FAF6/FAG6/FNF6/FMF6/FME6)				Flat K 21 M14x2 (2 pcs.) 10 Cromax + Magni	1.576.434	DF08
	Transit 2013				Flat K 21 M14x1,5 (2 pcs.) 10 Zinclud+Magni	1.811.812	DF09
	Transit 2013 (Single wheels only)				Konisk 60° K 21 M14x1,5 10 Zincnickel + s/s cap	ACPA-1012-KXA	DF10
	S-Max Galaxy				Konisk 60° K 21 M14x1,5 10 Zincnickel + s/s cap	5.275.544	DF11
HONDA							
	All passenger BILTYPEs				Kulekon R12 K 19 M12x1,5 8 White Zincplated	90381-SL5-901 90304-SC2-000	D14R

BOLTER OG MUTTERE OE TILBEHØR

BILDE	BILTYPE - TYPE	Felgtype	TEKNISKE DETALJER	OEM VARE#	BIMECC VARE#		
HONDA							
	Alle biltyper		Kulekon R12 K 19 M12x1,5 8 Zincoated + s/s cap	90304-SA5-013	D30R		
HYUNDAI							
	Atos (MX) Accent (LC, MC, MCT) Elantra (XD) Coupè (GK, J-2, RD)	Getz (TB, TBI) i 10 (IA, PA) i 20 (PB, PBT) i 30 (FD, FDH)	i 40 (VF) iX 20 (JC) iX 35 (EL, LM) Matrix (FC, FCT) Tucson (JM, TL)		Konisk 60° K 21 M12x1,5 8 Yellow Zincoated	52951-11210	DMTSB
LANCIA							
	Delta 3 (844) Kappa (838) Lybra (839)	Musa (350) Y (840, 312) Ypsilon (843, 846)			Konisk 60° K 17 M12x1,25x22/48,5 8.8 Deltaprotekt KL100	13.230.425	IBS13230425
LAND ROVER							
	Defender up to 2006 Discovery 1 Range Rover Classic				Flat K 27 M16x1,5 (2 pcs.) 8 Zincoated + s/s cap	ANR2763MMM	DRR
	Discovery 2				Flat K 22 M14x1,5 (2 pcs.) 8 White Zincoated	ANR3679	DRR1
	Defender from 2007				Flat K 27 M14x1,5 (2 pcs.) 8 Zincoated + s/s cap	RRD500560	DRR2
	Discovery 3 and 4 Range Rover Sport (LS) Range Rover Sport (LW) Range Rover Vogue (LM) Range Rover Vogue (LG)				Flat K 22 M14x1,5 (2 pcs.) 8 Zincoated + s/s cap	RRD500290	DRR3
	Range Rover Evoque Freelander 2 (LF) Discovery sport (LC)				Konisk 60° K 21 M14x1,5 10 Zincoated + s/s cap	LR001381	DF03
	Defender up to 2006 Discovery 1 Range Rover Classic				Konisk 80° K 27 M16x1,5 8 White Zincoated	RRD500010	DRR01-D

BOLTER OG MUTTERE OE TILBEHØR

BILDE	BILTYPE - TYPE	Felgtype	TEKNISKE Detaljer	OEM VARE#	BIMECC VARE#
MAZDA					
	Mazda 2 (DY, DE) 3 (BK, BL, BM) 5 (CR1, CW) 6 (GG, GG1, GJ) 121 (JASM)	323 (BF, BG, BA, BJ) 626 (GF) MPW (LW) MX3 (EC) MX5 (NA, NB, NC1)	MX6 Premacy (CP) RX-7 Demio (DW)	 Konisk 60° K 21 M12x1,5 8 Yellow Zincplated	0603 26 161 A DMTSB
	Mazda 2 (DY, DE) 3 (BK, BL, BM) 5 (CR1, CW) 6 (GG, GG1, GJ) 121 (JASM)	323 (BF, BG, BA, BJ) 626 (GF) MPW (LW) MX3 (EC) MX5 (NA, NB, NC1)	MX6 Premacy (CP) RX-7 Demio (DW)	 Konisk 60° K 21 M12x1,5 8 Zincplated + s/s cap	B002-37-160B D50
MERCEDES					
	180 (120) 190 (110) 200 (110) 220 (111) 230 (110)			 Kulekon R12 K 17 M12x1,5 8 White Zincplated	000 990 00 59 D95R
	Sprinter 616 (905) Vario 512 (667) 612 (668) 814 (670)	815 (670) 609 (668) 709 (669)		 Flat K 19 M12x1,5 10 White Zincplated	074361 014205 JDDBC14A19015Z
	Class A (168) C (202, 203) CLK (208, 209) E (210)	SL (129, 107) SLK (170, 171) Vaneo (414) 190 (201)	200 (124)	 Kulekon R12 K 17 M12x1,5x21/39,5 10.9 White Zincplated	170 401 01 70 201 401 02 70 000 990 45 07 210 401 02 70 LS17A21F
	Class A (168) C (202, 203) CLC (203) CLK (208, 209)	E (124, 210) SL (129) SLK (170, 171) Vaneo (414)	190 (201) 200 (124)	 Kulekon R12 K 17 M12x1,5x40/61 10.9 White Zincplated	124 400 01 70 000 990 48 07 124 400 00 70 124 400 04 70 202 400 00 70 000 990 10 07 203 401 02 70 S17A40 / B22
	CL (215) GE (461, 463) GLK (204 Steel wheels only) GLE (166, 292 Steel wheels only)	ML (164 Steel wheels only) R (251 Steel wheels only) GL (164)	S (140, 220)	 Kulekon R14 K 17 M12x1,5x45/70 10.9 Deltaprotekt KL100	000 990 53 07 S17D45R14PI
	Class S (140)			 Kulekon R12 K 17 M14x1,5x25/45 10.9 Deltaprotekt KL100	140 401 02 70 LS17D25FKL100
	Class A (169, 176) B (245, 246) C (204 alloy wheels only) CLS (218, 219) E (207, 211, 212) CLA (117)	GL (164 alloy wheels only) GLK (204) ML (163, 164 alloy wheels only) R (251 alloy wheels only)	SL (230) SLK (172) SLR (199) Viano (639 steel wheels only) GLA (156)	 Kulekon R14 K 17 M14x1,5x26,5/49 10.9 Deltaprotekt KL100	000 990 67 07 000 990 69 07 000 990 72 07 000 990 49 07 163 401 06 70 211 401 03 70 LS17D27R14

BOLTER OG MUTTERE OE TILBEHØR

BILDE	BILTYPE - TYPE			Felgtype 	TEKNISKE Detaljer	OEM VARE#	BIMECC VARE#
MERCEDES							
	Sprinter I only 5x130 (207, 208, 209, 210, 212, 214, 307, 308, 309, 310, 312, 314) Sprinter II only 5x130 (906)				Kulekon R14 K 19 M14x1,5x34/63 10.9 Zincnickel + Finigard 105	601 401 02 70	S19D34R14
	Class A (169, 176) B (245, 246) C (204 alloy wheels only) CLS (218, 219) E (207, 211, 212) CLA (117)	GL (164 alloy wheels only) GLK (204) ML (163, 164 alloy wheels only) R (251 alloy wheels only)	SL (230) SLK (172) SLR (199) Viano (639 alloy wheels only) GLA (156)		Kulekon R14 K 19 M14x1,5x27 10.9 Corrolube + s/s cap	000 990 51 07	LS17D27R14CI
	CL (215) GE (461, 463) GLK (204 alloy wheels only) GLE (166, 292 alloy wheels only)	ML (164 alloy wheels only) R (251 alloy wheels only) GL (164)	S (140, 220)		Kulekon R14 K 19 M14x1,5x45 10.9 Corrolube + s/s cap	000 990 54 07	S17D45R14CI
MINI							
	Cooper and Cooper S (R52, R53 up to 07/2006) JCW (R52, R53) One (R50 up to 07/2006)				Konisk 60° K 17 M12x1,5x26/51 8.8 Corrolube	36 13 0 141 574	B12PI
	Cooper and Cooper S (R52 from 07/2006, R53 from 07/2006, R55, R56, R57, R60)	Clubman (R55) Countryman (R60) JCW (R52, R55, R56, R57, R58)	One (R50 from 07/2006) One (R55, R56) Paceman (UKL)		Konisk 60° K 17 M14x1,25x27/48 8.8 Corrolube	36 13 6 781 151-03	C17F27PI2
MITSUBISHI							
	ASX (GA0) Carisma (DA0) Colt (C50, CAO, CJO, Z30, Z3B)	Galant (E30, EAO) i-Miev (HA0, HAV) Lancer (CSO, CYO) L300 (PAO, PAOV, POOV, POOW)	Outlander (CUOW, CWO) Pajero (H60W) Space Wagon (N10, N30, N50)		Konisk 60° K 21 M12x1,5 8 Yellow Zincplated	MR 297927 MA 103 087	DMTSB
	ASX (GA0) Carisma (DA0) Colt (C50, CAO, CJO, Z30, Z3B) Space Gear (PA0)	Galant (E30, EAO) i-Miev (HA0, HAV) Lancer (CSO, CYO) L300 (PAO, PAOV, POOV, POOW)	Outlander (CUOW, CWO) Pajero (H60W) Space Wagon (N10, N30, N50) Space Star (DG0, A00)		Flat K 21 M12x1,5 (2 pcs.) 8 Chromeplated	MR 455707	DTOY01
	ASX (GA0) Carisma (DA0) Colt (C50, CAO, CJO, Z30, Z3B)	Galant (E30, EAO) i-Miev (HA0, HAV) Lancer (CSO, CYO) L300 (PAO, PAOV, POOV, POOW)	Outlander (CUOW, CWO) Pajero (H60W) Space Wagon (N10, N30, N50)		Knurl Ø 14,3 Head Ø 18 M12x1,5x42/47 10.9 White Zincplated	MB 911495	CRP143A42

BOLTER OG MUTTERE OE TILBEHØR

BILDE	BILTYPE – TYPE			Følgtype  	TEKNISKE Detaljer	OEM VARE#	BIMECC VARE#
NISSAN							
	Pixo (HF)				Konisk 60° K 19 M12x1,25 8 White Zincplated	36181-4A0A2	D61
	Qashqai (J11)			 	Konisk 60° K 17 M12x1,5x24/49 10.9 White Zincplated	40254-00Q0P	B27
	Micra (K12) Note (E11)			 	Konisk 60° K 19 M12x1,5x25/51 10.9 White Zincplated	40254-00QAB 40222-BC40A	B15
	100NX (B13) 200SX Almera (N15, N16, V10) Juke (F15) Leaf (ZEO)	Maxima (A32, A33) Micra (K10, K11, K13) Note (E12) Patrol (260, K160, Y60A, Y61) Evalia, NV200 (M20M)	PicK-Up (D22) Primera (P11, P12) Qashqai (J10) Sunny (N14, B12, N13) Terrano (WD21, R20) X-Trail		Konisk 60° K 21 M12x1,25 8 Yellow Zincplated	40224-ZE73A 40224-G9501 40224-21001	DNIS
OPEL							
	Agila A (H00 up to chassis 3G999999)			 	Konisk 60° K 19 M12x1,25 8 White Zincplated	4705 171	D61
	Antara (L-A)				Konisk 60° K 19 M12x1,5 8 Zincplated + s/s cap	4803 304	D30
	Combo (D)			 	Konisk 60° K 17 M12x1,25x22/48,5 8.8 Deltaprotekt KL100	1.008.011	IBS13230425
	Antara (KLAC, KLAD) Astra J (P-J) Mokka (J-A) Zafira Tourer (P-J-SW) Karl (D-A) Cascada (P-J)			 	Konisk 60° K 19 M12x1,5 10 White Zincplated	1.008.010 1.008.516	D14CL10
	Mokka (J-A)				Konisk 60° K 19 M12x1,5 10 White Zincpl.+s/s cap.	1.008.013	DGM01
	Adam (S-D) Corsa (A-B-C-D-E) Agila A (H00 from chassis 3H000000)	Astra (F, G, H) Combo (C) Meriva (A, B) Omega (B)	Signum (Z-C-S) Tigra (S93, X-C) Vectra (A, B, C) Zafira (A-B)	 	Konisk 60° K 17 M12x1,5x22/47,5 10.9 White Zincplated	1.008.504	LC17A22F











BOLTER OG MUTTERE OE TILBEHØR

BILDE	BILTYPE - TYPE	Felgtype	TEKNISKE Detaljer	OEM VARE#	BIMECC VARE#		
	106 (1A, 1C) 205 (20A, 20C) 306 (7A, 7D) 309 (10A, 10C)	405 (15B, 15E) 406 (8B) 605 (6B) Partner (HDZ, NFU)		Flat K 19 M12x1,25x17/63 (2 pcs.) 10.9 White Zincplated	5405.35	VPE01-ZB	
	308 (4) 407 (6C, 6D) 3008 (OU) 5008 (O)	Expert 3 Partner 3 Tepee Ranch 3		Konisk 60° K 17 M12x1,25x26/49 (2 pcs.) 10.9 Deltaprotekt KL100	5405.72 1608734480	C17B24-MW	
	106 (1A, 1C) 205 (20A, 20C) 306 (7A, 7D) 309 (10A, 10C)	405 (15B, 15E) 406 (8B) 605 (6B) Partner (HDZ, NFU)		Konisk 60° K 19 M12x1,25x26/52 10.9 White Zincplated	5405.55	C19B26	
	206 (HFZ) 207 (W) 208 (C) 2008 (C) 301 (D)	307 (3A, 3C) 308 (4,L) 309 (L) 508 (8) 1007 (K)	Bipper Silver (225L) Expert 2 Tepee (G9) Expert 3 Tepee Partner (HDZ, NFU)		Konisk 60° K 17 M12x1,25x26/47 10.9 Deltaprotekt KL100	5405.66	B0400-001
	206 (HFZ) 207 (W) 208 (C) 301 (D) 307 (3A, 3C) 308 (1, 2, 4, L)	407 (6C, 6D) 508 (8) 607 (9D, 9U) 1007 (K) 2008 (C) 3008 (OU)	5008 (O) Expert 2 Tepee (G9) Expert 3 Tepee Partner (HDZ, NFU) RCZ		Flat K 17 M12x1,25x17/57 (2 pcs.) 10.9 Deltaprotekt KL100	5405.67	VPE03
	107 (P) 108 (580W)			Konisk 60° K 17 M12x1,5x21/47 10.9 White Zincplated	5405.77	C17A21	
	107 (P)			Flat K 17 M12x1,5x35/59,5 (2 pcs.) 10.9 Deltaprotekt KL100	5405.80	PZ406-9068000	
	108 (580W)			Flat K 17 M12x1,5x33/53,5 (2 pcs.) 10.9 Deltaprotekt KL100	5405.85	VPE05	
	807 (E)			Konisk 60° K 17 M14x1,5x26/56,5 (2 pcs.) 10.9 Deltaprotekt KL100	5405.69	B0046-002	











BOLTER OG MUTTERE OE TILBEHØR

BILDE	BILTYPE – TYPE	Felgtype 	TEKNISKE Detaljer	OEM VARE#	BIMECC VARE#
PEUGEOT					
	807 (E) Expert (B/222, X)		Konisk 60° K 17 M14x1,5x25/56,5 10.9 Deltaprotekt KL100	5405.68	B0046-001
	BOXER (230, 244 Axial load from 1,1 - 1,4 Ton.)		Konisk 60° K 24 M14x1,5x28,2/53 10.9 Deltaprotekt KL100	5405.75	B0046-003
	BOXER (230, 244 Axial load from 1,8 Ton.)		Konisk 60° K 24 M16x1,5x31/57 10.9 Deltaprotekt KL100	5405.76	B0046-004
	BOXER (250 Axial load 1,1 - 1,7 Ton.)	 (15" only)	Konisk 60° K 21 M14x1,5x27/62 10.9 Deltaprotekt KL100	5405.78	B0046-006
				5405.88	
	BOXER (250 Axial load from 1,6 Ton.)	 (16" only)	Konisk 60° K 21 M16x1,5x29/64 10.9 Deltaprotekt KL100	5405.79	B0046-007
	4007 (V) 4008 (B) I-on (1)		Konisk 60° K 21 M12x1,5 8 Yellow Zincplated	5405.81	DMTSB
	4007 (V) 4008 (B)		Flat K 21 M12x1,5 (2 pcs.) 8 Chromeplated	5405.82	DTOY01
	4007 (V) 4008 (B) I-on (1)		Knurl Ø 14,3 Head Ø 18 M12x1,5x42/47 10.9 White Zincplated	3714.28	CRP143A42
PORSCHE					
	911 912 914 924 944		Kulekon R14 K 19 M14x1,5 10 White Zincplated	N 020 112 1	D17R
	911 (930, 964, 993, 996 from 2000, 997) Boxter (986, 987) Cayman (9TA) Panamera (970)		Kulekon R14 K 19 M14x1,5x30/60 (2 pcs.) 10.9 Deltaprotekt KL100	997 361 203 01	PS19D30- MWA

BOLTER OG MUTTERE OE TILBEHØR

BILDE	BILTYPE - TYPE		Felgtype 	TEKNISKE Detaljer	OEM VARE#	BIMECC VARE#
PORSCHE						
	Cayenne			Kulekon R14 K 19 M14x1,5x37/67 (2 pcs.) 10.9 White Zincplated	7L0 601 139 A	PS19D37-MW
	Macan (95B)			Kulekon R14 K 19 M14x1,5x30/60 (2 pcs.) 10.9 Zinc nickel black	996 352 086 02 WHT 006 978	PS19D30ZN- MWA
RENAULT						
	Clio (B, C57) Espace (S115) Kangoo (KC) Laguna (B56, K56)	Megane (BA, DA, LA, EA) Thalia/Symbol (B) Twingo (C06)	R5 (B-C40, F40) R19 (B-C53, X53, L53) R21 (L48)		Konisk 60° K 19 M12x1,5x25/51 10.9 White Zincplated	82 00 030 701 82 00 719 981 B15
	Capture (R) Clio (R) Kangoo (W, FW) Laguna (G)	Megane (M, JM, Z, JZ) Modus (P) Twingo (N, AH) Zoe (AG)	Kadjar (RFE)		Konisk 60° K 17 M12x1,5x24/50 10.9 White Zincplated	82 00 473 353 40 22 221 21R B27
	Koleos (Y)				Konisk 60° K 21 M12x1,5 8 Yellow Zincplated	40224-21001 DMTSB
SEAT						
	Arosa (6H, 6HS) Cordoba (6K, 6K/C) Ibiza (6K) Inca (9KS, 9KSF)	Mii (AA) Toledo (1L 4x100 only)			Kulekon R13 K 17 M12x1,5x24,5/45,7 10.9 White Zincplated	3A0 601 139 321 601 139C WHT 004 899 LS17A25F-Z
	Alhambra (7N) Altea (5P) Cordoba (6L) Exeo (3R)	Ibiza (6L, 6J) Leon (1P, 1PN, 5F) Toledo (1L 5x100 only, 1M, 5P, NH)			Kulekon R13 K 17 M14x1,5x27/47,5 10.9 White Zincplated	WHT 002 437 LS17D27F
	Alhambra (7MS from 1996 to 2000)				Kulekon R14 K 19 M14x1,5x34/55 10.9 Black Zincnickel	701 601 139 B LS19D34F
	Alhambra (7MS from 2001 to 2010)				Kulekon R14 K 19 M14x1,5x34/62 (2 pcs.) 10.9 Deltaprotekt KL100	7M3 601 139B LS19D34F-MW

BOLTER OG MUTTERE OE TILBEHØR

BILDE	BILTYPE - TYPE	Felgtype	TEKNISKE Detaljer	OEM VARE#	BIMECC VARE#	
SKODA						
	Citigo (AA) Favorit (781) Felicia (791, 795, 797)		Kulekon R13 K 17 M12x1,5x24,5/45,7 10.9 White Zincplated	WHT 004 899 3A0 601 139	LS17A25F-Z	
	Fabia (6Y, 5J) Octavia (1U, 1Z, 5E) Rapid (NH) Roomster (5J)	Superb (3U, 3T) Yeti (5L)		Kulekon R13 K 17 M14x1,5x27/47,5 10.9 White Zincplated	WHT 002 437 LS17D27F	
SMART						
	Forfour (454)		Knurl Ø 14,3 Head Ø 18 M12x1,5x42/47 10.9 White Zincplated	454 350 01 35 S1	CRP143A42	
	Forfour (454)		Konisk 60° K 21 M12x1,5 8 Yellow Zincplated	454 402 00 72	DMTSB	
	Fortwo, Forfour (W453)		Konisk 60° K 17 M12x1,5x24/49 10.9 White Zincplated	A4539900007	B27	
SUZUKI						
	Alto (FF, GF) Baleno (EG) Ignis (FH) Grand Vitara (JT)	Jimny (FJ) Kizashi (FR) Liana (ER) Swift (EA, MA)	SX4 Wagon R+ (EM) Celerio (LF)		Konisk 60° K 19 M12x1,25 8 White Zincplated	09140-12042 D61
	Ignis (MH) Splash (EX) Swift (EZ/MZ, NZ/FZ) Wagon R+ (MM, H00) Vitara (LY)			Konisk 60° K 17 M12x1,5x22/47,5 10.9 White Zincplated	43423-86G00 LC17A22F	
TESLA						
	Model S		Konisk 60° K 21 M14x1,5 10 Zincnickel + s/s cap	ACPA-1012-KXA	DF10	













BOLTER OG MUTTERE OE TILBEHØR

BILDE	BILTYPE - TYPE		Felgtype	TEKNISKE Detaljer	OEM VARE#	BIMECC VARE#	
	Auris (E15J, E18UM) Avensis (T22, T25, T27, M2) Camry (V2, V10) Carina (T19U) IQ (AJ1)	Celica (T18, T20) Corolla (E10, E11, E12, R1) Hiace (H1) Hilux (N1, N16, N25S)	Paseo (L5) Previa (R3) Prius (HW2, HW3, HW4) RAV 4 (A2, XA3) Urban Cruiser (XP11) Yaris (P1, P2, XP9, XP13M)		Konisk 60° K 21 M12x1,5 8 Yellow Zincplated	90942 01007	DMTSB
	Auris (E15J, E18UM) Avensis (T22, T25, T27, M2) Camry (V2, V10) Carina (T19U) Celica (T18, T20)	Corolla (E10, E11, E12, R1) Hiace (H1) Hilux (N1, N16, N25S) IQ (AJ1) Paseo (L5)	Previa (R3) RAV 4 (A2) Yaris (P1, P2, XP9, XP13M) Urban Cruiser (XP11) Prius (HW2, HW3, HW4)		Flat K 21 M12x1,5 (2 pcs.) 8 Chromeplated	90942-01033	DTOY01
	4 Runner Land Cruiser Prado Rav 4 Highlander	Lexus ES300, GS300-400-430 (from '08/96) GX470 IS200-300 (from '07/01) LS400-430 (from '01/00)	RX300-400H (from '01/98) SC300-400-430 (from '01/97)		Flat K 21 M12x1,5 (2 pcs.) 8 Chromeplated	90942-01058	DTOY03
	Land Cruiser 70, 100, 200, 400 Tundra Lexus LX470, LX570				Flat K 22 M14x1,5 (2 pcs.) 8 Chromeplated	90942-01103	DTOY04
	Aygo (AB1)				Konisk K 17 M12x1,5x21/47 10.9 White Zincplated	90942-W2001	C17A21
	Aygo (AB1)				Flat K 17 M12x1,5x35/59,5 (2 pcs.) 10.9 Deltaprotekt KL100	90942-W2002	PZ406-9068000
	Aygo (580W)				Flat K 17 M12x1,5x33/53,5 (2 pcs.) 10.9 Deltaprotekt KL100	90942-W2003	VPE05

BOLTER OG MUTTERE OE TILBEHØR

BILDE	BILTYPE - TYPE	Felgtype	TEKNISKE Detaljer	OEM VARE#	BIMECC VARE#		
	Transporter T2 Transporter T3		Kulekon R14 K 19 M14x1,5 10 White Zincplated	N 020 112 1	D17R		
	Caddy (9KVF, 9U) Corrado (53I, 4x100 only) Golf (155, 19E, 1H 4x100 only)	Jetta (19E) Lupo (6X) Passat (35I, 35I-299) Polo (86C, 6N, 6NF)	Scirocco (53) Up (AA) Vento (1H 4x100 only)		Kulekon R13 K 17 M12x1,5x24,5/45,7 10.9 White Zincplated	321601139 C 3A0 601 139 WHT 004 899	LS17A25F-Z
	Sharan (7M from 1995 to 2000) Transporter T4 (7DZ)		Kulekon R14 K 19 M14x1,5x34/55 10.9 Black Zincplated	701 601 139 B 7M0 601 139A	LS19D34F		
	Sharan (7M from 2000 to 2010) Transporter T4 (2001-2003)		Kulekon R14 K 19 M14x1,5x34/62 (2 pcs.) 10.9 Deltaprotekt KL100	7M3 601 139 B	LS19D34F-MW		
	Bora (1J, 9M, 1K) Beatie (16) Caddy (2K, 2KN, 2CA) CC (358) Corrado (53I 5x100 only)	Eos (1F) Fox (5Z) Golf (1H 5x100 only, 1J, 1K, 1KM, 1KP, AU) Jetta (1KM, 16) Nyhet Beatle (9C, 1Y)	Passat (3B, 3BG, 3C) Polo (9N, 6R) Scirocco (13) Sharan (7N) Touran (5T) Tiguan (5N)		Kulekon R13 K 17 M14x1,5x27/47,5 10.9 White Zincplated	WHT 002 437	LS17D27F
	Phaeton (3D)		Kulekon R13 K 17 M14x1,5x27/51 (2 pcs.) 8.8 White Zincplated	4D0 601 139 A	LS17D27F-MW2		
	Touareg (7L, 7P) Transporter T5 (7H)		Kulekon R14 K 19 M14x1,5x37/67 (2 pcs.) 10.9 White Zincplated	7L0 601 139 A	PS19D37-MW		
	Crafter 30/35 (2EC1, 2FJ1) LT28/35 (2DM)		Kulekon R14 K 19 M14x1,5x34/63 10.9 Zincnickel+Finigard 105	2D0 601 139 WHT 000 888	S19D34R14		

BOLTER OG MUTTERE OE TILBEHØR

BILDE	BILTYPE – TYPE			Felgtype 	TEKNISKE Detaljer	OEM VARE#	BIMECC VARE#
	240-260 (P244, P245)				Konisk 60° K 19 1/2" UNF 8 Zincplated + s/s cap	1273332	D33
	S40/V40 (V)				Konisk 60° K 21 M12x1,5 8 Yellow Zincplated	30870000 30873148	DMTSB
	C30 (M) S40/V50 (M) S90/V90 (9) V40 (M)				Konisk 60° K 19 M12x1,5 10 Deltaprotekt KL100	8665333 999359	D60FB
	C30 (M) S40/V50 (M) S90/V90 (9) V40 (M)				Konisk 60° K 19 M12x1,5 10 Zincplated + s/s cap	31329645	DF02N
	850 (L, LS, LW) S70/V70 (L)				Konisk 60° K 19 M12x1,75x28,5/55 10.9 White Zincplated	3546651	VOLVO
	S60 (RH, F) S80 (A, T) V60 (F) C70 (N)	S70/V70 (G) S80 (T/K/KW, A) V70 (J) XC60 (D) V70/XC70 (B)	XC90 (C,L)		Konisk 60° K 19 M14x1,5x34/60 (2 pcs.) 10.9 White Zincplated	31362432	C19D34-MW

All informasjon i denne listen har blitt nøye utarbeidet av Bimecc, men vi anbefaler sterkt og henviser derfor til bilens brukermanual, og å eventuelt kontakte et autorisert dekkverksted for utskifting av bolter og muttere. Norgesdekk fraskriver seg ethvert ansvar for eventuelle feil bruk av disse.



NORGESDEKK AS, avd Bergen
Nordre Toppe 6
5878 Bergen
Tlf. 4000 1800
bergen@norgesdekk.no

NORGESDEKK AS, avd Jæren
Jærvn. 338
4322 Sandnes
Tlf. 4000 1800
post@norgesdekk.no

NORGESDEKK AS, avd Kristiansand
Stemmane 6
4636 Kristiansand
Tlf. 4000 1800
kristiansand@norgesdekk.no

NORGESDEKK AS, avd Tønsberg
Borgeskogsvingen 15
3160 Stokke
Tlf. 4000 1800
tonsberg@norgesdekk.no

NORGESDEKK AS, avd Oslo
Landskaugveien 54
1914 Ytre Enebakk
Tlf. 4000 1800
oslo@norgesdekk.no

NORGESDEKK AS, avd Trondheim
Øybergveien 133
7224 Melhus
Tlf. 4000 1800
trondheim@norgesdekk.no

NORGESDEKK AS, avd Narvik
Ornesveien 5
8517 Narvik
Tlf. 4000 1800
narvik@norgesdekk.no